

DOCUMENT RESUME

ED 287 680

SE 048 634

TITLE Science: Model Curriculum Guide, Kindergarten through Grade Eight.

INSTITUTION California State Dept. of Education, Sacramento.

REPORT NO ISBN-0-8011-0665-6

PUB DATE 87

NOTE 134p.; For the related mathematics curriculum, see SE 048 611.

AVAILABLE FROM Publications Sales, California State Department of Education, P.O. Box 271, Sacramento, CA 95802-0271 (\$3.25 plus tax).

PUB TYPE Guides - Classroom Use - Guides (For Teachers) (052)

EDRS PRICE MF01 Plus Postage. PC Not Available from EDRS.

DESCRIPTORS Biological Sciences; Earth Science; Elementary Education; *Elementary School Science; Interdisciplinary Approach; Physical Sciences; Process Education; *Science Activities; Science Education; Science Experiments; *Science Instruction; State Curriculum Guides

IDENTIFIERS *California

ABSTRACT

This guide was developed with the intention of helping teachers and school site administrators in California review the elementary science curriculum and compare it to an idealized model that is presented in the document. Part I of the guide provides a summary of a number of characteristics considered to be important to a strong elementary science program. It was designed to aid teachers, principals, and parents in identifying features of their local science program where attention is needed. Part II presents a full-scale portrait of an elementary science program that focuses on the development of student understanding. This section presents teaching ideas that are concerned with both the knowledge base and science process skills. Common themes are present in the discussion of science instruction in the various subject areas. The disciplines and associated themes addressed are: (1) biological science (cells, genetics, evolution, plants, protists, animals, human beings, ecosystems); (2) earth science (astronomy, geology and natural resources, meteorology, oceanography and hydrology); and (3) physical science (matter, mechanics, energy sources and transformation, heat, light, electricity, magnetism, and sound). (TW)

 * Reproductions supplied by EDRS are the best that can be made *
 * from the original document. *

ED287680

Science

FOR JARVIS TROTT
PAGE EIGHT

U.S. DEPARTMENT OF EDUCATION
 Office of Educational Research and Improvement
EDUCATIONAL RESOURCES INFORMATION CENTER (ERIC)

This document has been reproduced as received from the person or organization originating it.

Minor changes have been made to improve reproduction quality.

• Points of view or opinions stated in this document do not necessarily represent official OERI position or policy.

"PERMISSION TO REPRODUCE THIS MATERIAL IN MICROFICHE ONLY HAS BEEN GRANTED BY

J. Smith

TO THE EDUCATIONAL RESOURCES INFORMATION CENTER (ERIC)."

Science

MODEL CURRICULUM GUIDE

KINDERGARTEN THROUGH
GRADE EIGHT

SE 048 634



Publishing Information

The *Science Model Curriculum Guide. Kindergarten Through Grade Eight* was developed by an advisory committee (see page ix) working in cooperation with Thomas Sachse, Manager, Mathematics/Science Education Unit, State Department of Education. Artifax Corporation of San Diego prepared the *Guide* for photo-offset production, and Cheryl Shawver McDonald of the Bureau of Publications designed and prepared the artwork for the cover.

The *Science Model Curriculum Guide* was published by the California State Department of Education, 721 Capitol Mall, Sacramento, California (mailing address: P.O. Box 944272, Sacramento, CA 94244-2720); was printed by the Office of State Printing; and was distributed under the provisions of the Library Distribution Act and *Government Code* Section 11096.

Copyright © 1987, California State Department of Education

Copies of this publication are available for \$3.25 each, plus sales tax for California residents, from Publications Sales, California State Department of Education, P.O. Box 271, Sacramento, CA 95802-0271. Other publications that are available from the Department may be found on pages 125-26, or a complete list may be secured by writing to the address above or by calling the sales unit in the Bureau of Publications: (916) 445-1260.

ISBN 0-8011-0665-6

CONTENTS

Foreword	v
Preface	vii
Acknowledgments	ix
Overview	1
Part I	3
Designing the Program	3
Operating the Program	5
Part II	9
Biological Science (K-3)	9
A. Cells, Genetics, and Evolution	9
B. Plants	11
C. Protists	12
D. Animals	13
E. Human Beings	14
F. Ecosystems	14
Earth Science (K-3)	16
A. Astronomy	16
B. Geology and Natural Resources	18
C. Oceanography and Hydrology	21
Physical Science (K-3)	23
A. Matter	23
B. Mechanics	24
C. Energy: Sources and Transformation	25
D. Heat	26
E. Light	27
F. Electricity and Magnetism	28
G. Sound	30
Biological Science (4-6)	32
A. Cells, Genetics, and Evolution	32
B. Plants	33
C. Protists	35
D. Animals	36
E. Human Beings	39
F. Ecosystems	40

Earth Science (4-6)	42
A. Astronomy	42
B. Geology and Natural Resources	44
C. Meteorology	46
D. Oceanography	48
Physical Science (4-6)	50
A. Matter	50
B. Energy	52
C. Mechanical Energy	53
D. Heat Energy	54
E. Light Energy	55
F. Sound Energy	57
G. Electricity and Magnetism	58
Biological Science (7-8)	60
A. Cells, Genetics, and Evolution	60
B. Plants	62
C. Protists	63
D. Animals	64
E. Human Beings	64
F. Ecosystems	66
Earth Science (7-8)	69
A. Astronomy	69
B. Geology and Natural Resources	71
C. Meteorology	73
D. Oceanography	75
Physical Science (7-8)	78
A. Matter	78
B. Mechanics	82
C. Energy: Sources of Transformations	82
D. Energy: Heat	83
E. Energy: Light	84
F. Energy: Electricity and Magnetism	85
G. Energy: Sound	87
Appendixes	89
I. Biographies of Scientists	91
II. Scientific Discoveries	105
III. Scientific Literature	113
IV. Science Materials	121

FOREWORD

"... the first principles which are instilled take the deepest root ..."

Abigail Adams, Letter to John Adams, August 14, 1776

The importance of the elementary school experience cannot be overstated. The first connections that our children make with formal learning lay the foundation on which their future education will be built. If through their day-to-day school experiences students find that learning is important, interesting, and meaningful to their lives—and if we help students not only to want to learn but also to know that they can learn—we have put in place important building blocks for a solid academic foundation. Yet, to value learning and to want to learn are not the only ingredients of the foundation. The content of the curriculum—what we teach our children—ultimately determines how well they are prepared for the challenges of further education and for productive adult life.

California's attention to the content of the elementary school curriculum is part of the state's comprehensive curriculum improvement efforts. With the Hughes-Hart Educational Reform Act of 1983 (Senate Bill 813), California reinstated high school graduation requirements, which increase for many schools the number of courses required for graduation. The legislation also mandated publication of the *Model Curriculum Standards, Grades Nine Through Twelve*, which is intended to help high schools improve the quality of academic coursework. The *Model Curriculum Guides, Kindergarten Through Grade Eight* are aligned with the state's *Model Curriculum Standards*, as well as with our frameworks, handbooks, and assessment programs. Together, the *Guides* and the *Standards* are intended to engage each student from kindergarten through grade twelve in interesting, disciplined academic study. Their overarching purpose is to ensure that all California schools are able to address the state's most critical educational needs to:

- Prepare youth for productive adult employment in an economy increasingly dependent on highly skilled, highly literate employees.
- Graduate informed, thoughtful citizens who understand the shared values and ethical principles essential for a healthy, functioning democracy.
- Produce culturally literate adults who have learned not only basic skills but also a common body of concepts and central works of history, literature, English-language arts, science, mathematics, social science, foreign languages, and the arts and through this study possess a strong sense of a shared tradition and cultural heritage.

The task of developing a curricular model appropriate for all students is enormous. Students in many of our schools come from widely diverse ethnic, racial, linguistic, and economic backgrounds. They also develop at very different paces academically, physically, and emotionally. To prepare so diverse a student population for the complex world of their future, educational leaders in California and nationally urge the adoption of a rigorous, integrated

core curriculum that begins in kindergarten and builds from grade to grade through high school, as described here:

- A core curriculum of study validates each student's individuality and unique strengths while engaging all children in meaningful investigation of the common knowledge, values, and skills needed for productive adult life. Students study the beliefs which form the ethical and moral bonds of our nation. They develop an understanding of civic responsibility in a pluralistic, democratic society and learn the technological literacy needed for our increasingly complex society. A common core curriculum ensures each student a sound educational foundation and develops fully the student's academic, ethical, and political potentials.
- In an integrated curriculum, teachers incorporate through the lessons they teach the knowledge and skills from two or more disciplines. In integrated units of study, teachers emphasize the rich connections among content areas, teach students the interrelatedness of knowledge and skills, and foster a holistic view of learning. Through the integration teachers also extend instructional time in subjects structured as integrated lessons. In a science lab in which students record their observations in concise, declarative sentences and read about one another's discoveries, for example, the students learn reading and writing along with science concepts.

At the beginning of this foreword, I quoted from a letter Abigail Adams wrote to her husband. Now I close with a most appropriate quote from a letter she wrote to her son, John Quincy Adams: "Learning is not obtained by chance; it must be sought for with ardor and attended to with diligence." As we build new curricula for our elementary schools, we need to keep both of Mrs. Adams's ideas clearly in mind: Those first principles that we teach our children lay a foundation that must not be permitted to assemble by chance. This guide and the other materials we have produced to support our educational reform efforts in California will help ensure that the education of our children will not be left to chance but will be pursued with the diligence and insight of an Abigail Adams.



Superintendent of Public Instruction

PREFACE

The *Model Curriculum Guides* set forth the essential learnings for elementary and middle school English-language arts, mathematics, and science curricula. And guides for social science, history, fine arts, physical education, and foreign languages are being prepared.

Although the *Guides* are not mandatory, they are intended as evocative models of curriculum content. Individual schools will probably modify and expand the content, as appropriate, for their particular student populations. For each subject, the *Guides* suggest a learning sequence, delineating concepts, skills, and activities appropriate for learners in kindergarten through grade three, grades three through six, and grades six through eight. The sequences are suggestive. Teachers' judgments about a particular student's readiness for more advanced instruction will ultimately determine when new concepts and skills are introduced.

Sequencing essential learnings for various grade levels is useful in organizing so large a body of information. Yet, the overarching message of the *Guides* is that learning is not linear. It is a process that involves a continuous overlay of concepts and skills so that students' understandings are ever-broadened and ever-deepened. The content and model lessons of the *Guides* are structured to help teachers lead discussions, frame questions, and design activities that contain multiple levels of learning. Examples indicate how knowledge at one level can be reinforced and expanded as students advance through the curriculum. The organization of material is intended to help teachers move each student quickly from skill acquisition to higher order learning while, at all times, fully engaging the student in rigorous academic study.

The shift of emphasis from mastering basic skills to understanding thoroughly the content of the curriculum is intentional. Research indicates that children will learn more—and more effectively—if teachers focus lessons on content and the connections among subject areas. Students learn to apply skills by reading, writing, and discussing curriculum content. The essential learnings emphasize central concepts, patterns, and relationships among subject areas and reinforce inquiry and creative thinking.

Whenever possible, lessons include background information about the works, ideas, and leaders that have shaped the discipline. Such contextual knowledge helps students understand the way in which people discover and apply information under particular circumstances to advanced fields of knowledge. This fuller picture of academic content develops students' cultural and technological literacies—their ability to see both the content of the discipline and the broader context out of which facts and concepts evolve.

The *Model Curriculum Guides, Kindergarten Through Grade Eight* will be successful if they help elementary and middle school communities shape an integrated, active core curriculum that prepares students for the challenges of secondary school and beyond. The building blocks of an academic foundation are in place in many of our elementary schools. Yet, so important is the foundation—not only to children and their families but also to our future communities and the nation as a whole—that we must make every effort to ensure that, in every school and for every child, the elementary curriculum is the best that we can provide.

"The beginning is the most important part of the work."

Plato, The Republic

JAMES R. SMITH
Deputy Superintendent
Curriculum and Instructional Leadership

FRANCIE ALEXANDER
Director
Curriculum, Instruction,
and Assessment Division

THOMAS P. SACHSE
Manager
Mathematics/Science Education

ACKNOWLEDGMENTS

Del Alberti, Superintendent, Auburn Union Elementary School District

Maureen Allen, Elementary Science Specialist, Irvine Unified School District, Laguna Hills

Dawn Binder, Science Project Specialist, Green Acres Elementary School, Live Oak Elementary School District, Santa Cruz

Mary Ann Church, Math/Science Coordinator, San Joaquin County Office of Education, Stockton

Robert Clarillos, Science Resource Teacher, Los Angeles Unified School District

Harriet Cohen, Teacher, Park Day School, Oakland

Diane Conradson, San Jose State University, Biology Department

Perry Dyke, Pediatrician / Parent, Redlands

Rodney Edgmon, Principal, Noble Elementary School, Bakersfield City Elementary School District

Gary Estep, Teacher, Chico Junior High School, Chico Unified School District

Philip Gay, Science Specialist, San Diego City Unified School District

Peter C. Gega, Professor of Teacher Education, San Diego State University

David George, Panama Union Elementary School District, Bakersfield

Al Gunther, Stephen M. White Junior High School, Los Angeles Unified School District

Colleen McDonald, San Diego City Unified School District

Steve McKay, Anderson Valley Junior-Senior High School, Boonville

Alicia Meza, Assistant Superintendent, Sacramento City Unified School District

Rosa Nagaishi, Chemistry Teacher, Marshall High School, Los Angeles Unified School District

Gary Nakagiri, Science CIC, Parkside Center, San Francisco

Kathy Patterson, Teacher, Evergreen Elementary School, Evergreen Union Elementary School District, Cottonwood

Mary Anna Quon-Warner, Science Resource Teacher, Escondido Union School District

Thomas Sachse, Manager, Math/Science Education Unit, California State Department of Education

Jeff Self, Teacher, Eureka City Elementary School District

Sid Sitkoff, Elementary Science Specialist, Los Angeles Unified School District

Mare Taagepera, University of California, Department of Chemistry, Irvine

Edith Young, Coordinator, Hacienda Science/Environmental Magnet School, San Jose Unified School District

Special acknowledgments are due **Zack Hanscom**, Professor, San Diego State University, for appendixes I, II, and III.

Tom Craig created Appendix IV and is also due special thanks.

NOTE: The roles and job titles cited above are those of the listed individuals during the development of this document.

The *Science Model Curriculum Guide* was written for the purpose of having teachers and school site administrators review the elementary science curriculum and compare it to the idealized model which appears in the pages that follow. The *Model Curriculum Guides* (like the *Model Curriculum Standards*) will be used for comparisons at the school and district levels and are useful for creating a dialogue among those most responsible for and knowledgeable of the local science curriculum. The *Science Model Curriculum Guide* was drafted by a talented committee of science teachers and science specialists who worked to craft a document that is especially vivid in terms of the science lessons that are portrayed along with each guideline. The guidelines themselves (which appear in boxes throughout the document) are correlated to the *Science Framework Addendum* and also articulated with the *Model Curriculum Standards*. As such, the *Model Curriculum Guide* will be another vehicle for supporting the instructional materials found in textbooks and those educational technology software materials that have been reviewed and matched with the *Science Framework Addendum*.

The ultimate goal for science education remains that of science literacy for all students in California. The definition of science literacy has been well articulated elsewhere and consists of the following four elements:

1. Developing positive attitudes about science and taking an active interest in natural phenomena and technological achievements
2. Learning fundamental concepts of science and how the applications of these concepts affect our daily lives
3. Learning techniques that compose the scientific method to validate knowledge and to develop thinking skills for lifelong learning
4. Using attitudes and knowledge about science to live as an informed citizen in a technologically advanced nation

The goal of science literacy for California students is best reached by a thoughtful approach to integrating the science curriculum with other areas of study. The reader will note throughout the *Science Model Curriculum Guide* numerous references to learning activities that can be integrated with the visual and performing arts, English-language arts, mathematics, and history-social science. The appendices at the end of the document further elaborate on the resources and materials that can be used to integrate science with other areas. For example, the appendices dealing with biographies of scientists and scientific discoveries are especially useful in cross-curriculum integration with English-language arts and history-social science. Moreover, the list of scientific literature is an especially interesting avenue for students to avail themselves of good science reading while learning reading and other language arts skills.

Part I of the Document

The guide was developed with the expectation that it will serve different purposes for different readers. Part I provides a relatively brief summary of a number of important characteristics of a strong elementary science program. It is designed to aid teachers, principals, and parents in identifying features of the local science program where attention is needed. For some readers it will provide primarily an initial appreciation; for others, it will provide a kind of checklist either before or during an intensive examination of a school's program. Part I is intended to identify hallmarks that a wide range of professionals and lay people can turn to repeatedly in an ongoing planning and evaluation process.

Part II of the Document

Part II presents a full-scale portrait of an elementary science program focused on the development of student understanding. It is designed to be a guide and resource for persons with major responsibility for science curriculum or staff development. It will help them to establish specifications and assessment criteria for long-term improvement efforts. Elementary teachers can and should, over a period of time, read Part II carefully to acquire a more tangible vision of the science program that they can, with sustained support, gradually provide. Throughout Part II, the process skills (consistent with the *Science Framework Addendum*) are underlined to reinforce the expectation that science lessons impart both the science content (or knowledge base) and the science processes (or scientific methods). In addition, superscripts are used to denote teaching ideas presented in the appendices: ¹ biographies of scientists; ² scientific discoveries; and ³ scientific literature. The superscript ⁴ is used to denote lessons which lend themselves to cross-curriculum interpretation.

All students have the right to a science education that prepares them to take their place in society as scientifically literate citizens. Experiencing science as students helps them understand the natural and technological world as adults and helps them make our world a better place in which to live. Functional knowledge of science gives students skills for lifelong learning, understanding, and action. It provides a means for coping with and responding to the rapid changes in technology that directly affect their welfare. The development of a scientifically literate populace is a necessity, not a luxury.

At the elementary level students bring a natural curiosity to the classroom. They have a thirst for knowledge. They tenaciously hang on to any dis-

covery they make during exploration. They take pride in explaining difficult concepts and love to reel off the minutest detail about fascinating science facts. They are excited about learning and when given a chance, pursue science with enthusiasm. Science brings this excitement to the classroom; teachers need only to capitalize on this innate eagerness to know. Science education is a natural, exciting, and rewarding extension of youth itself. Therefore, it is incumbent on elementary teachers to ensure that this enthusiasm and excitement are maintained throughout the student's academic career. Part I of this document presents the factors that are most commonly found in successful elementary and middle school science programs.

DESIGNING THE PROGRAM

Organizing a consistent, well-rounded science education program requires the participation and dedication of the entire school staff. It is not an easy task; no worthwhile educational endeavor is. But it is a rewarding task for teachers and students that builds the character of the whole school mission. Of course, coordinating the development of a quality science program requires the support and direct involvement of the school site leadership. Several issues are paramount in designing science instruction.

Time Allocations for Science Instruction

A comprehensive school program requires adequate time for science instruction in grades K-12. Specific time allocations should be assigned to ensure the acquisition of scientific knowledge, positive attitudes toward science, rational and creative thinking skills, and manipulative communicative skills. A schedule of 100 minutes weekly in grades K-3, 150 minutes weekly for grades 4-6 (with an additional 50 minutes weekly for health in grades K-6), three semesters in grades 7-8, and two full years during grades 9-12 should be allocated. Students preparing for

higher education should devote a minimum of three years to the study of biology, chemistry, and physics at the high school level. Time alone is not a guarantee for a quality science program, but a concerned and enthusiastic teacher, combined with parental and community support, will ultimately contribute to a high quality science education program.

Program Support

Teachers of science universally report the need for administrative support to achieve and sustain a comprehensive science program like the one called for in this guide. This support usually translates into establishing science as a priority subject and providing the special resources necessary to sample the diversity and establish the integral nature of science as a discipline and endeavor. To be treated as a priority subject, science education would have to obtain the instructional status of language arts, mathematics, and the social sciences. This means more time, higher quality time, and equivalence in expenditures for materials, staff development, and assessment. As an instructional priority, the science program

would assume an equivalent place on report cards, in parent-teacher conferences, and in extracurricular activities. Finally and perhaps most important, superintendents and principals would need to talk and act as though science were a priority subject.

Recent surveys of teachers of science (especially those in elementary classrooms) have called for smaller class sizes and more supplies so that students can take an active role in science activities. If fiscal constraints preclude reducing class sizes at the school site, instructional aides employed with categorical or general funds can be used to maintain safety and order in science classes. Teachers of science also report dividends from sharing their instructional and experimental techniques. Each teacher who contributes ideas and procedures to others helps to improve competence in science education.

Spiraling and Articulation

Like the other curriculum areas, science education benefits from early introduction and careful repetition at higher cognitive levels throughout the grade levels. It should present concepts by increasing breadth and complexity at appropriate intervals. In grades K-6, instruction needs to introduce and continually reinforce the study of a wide range of science phenomena. In grades 7-8, earth, life, and physical science concepts learned in the lower grades should be reviewed and expanded. In-depth instruction in earth/space science, biology, chemistry, physics, etc., should be offered during grades 9-12.

Spiraling will require the continuous review and progression of knowledge and experiences over the different grade levels. This review and progression of knowledge will require careful articulation between teachers at all levels. All teachers must cover the agreed on science concepts. The 1984 *Science Framework Addendum* and Part II of this document should be consulted for specific expectations for learners' achievement in science.

Facilities, Equipment, and Instructional Materials

Facilities, equipment, and instructional materials must be selected, maintained, and updated to meet the needs of a quality program. As a first priority, students should have up-to-date instructional materials that adequately cover the knowledge base that learners are expected to acquire. If a primary text does not cover all the desired content, ancillary materials should be obtained. Another priority is to arrange for a host of demonstrations and experiments that reinforce what students learn in more didactic presentations. Here is where the science lesson comes to life. Appendix IV in this document lists desired science materials by grade level span. The materials of a science education must be mutually reinforcing; the print, as well as all forms of non-print, materials should interrelate and focus on the instructional outcomes.

Staff Development

Any successful science program must depend on well-prepared, dedicated teachers. Teachers of science must meet the most rigorous standards for subject matter knowledge and teaching expertise. Teachers must model appropriate behaviors in the classroom. This modeling involves showing enthusiastic attitudes about science (such as inquisitiveness and open-mindedness), demonstrating procedures consistent with those of a professional scientist (such as laboratory safety and experimental rigor), and exhibiting exemplary personal behavior (such as humane treatment of animals and environmental concerns). Because the enormous breadth of content areas and changing fields of science mandate a constant updating of science teachers, we must ensure that there are provisions for professional development and in-service opportunities. Staff development does not end with teacher training. School administrators need to know how to judge the quality of the science program and how to improve it. Department chairpersons and principals need to take advantage of science education programs to help them in the pursuit of excellence.

Evaluation

One key to the success of any science program is its evaluation. There are many valid means of evaluating the progress of a science program. Science programs, including the experiential aspects, can be evaluated by means of an assessment model such as that described in the Department of Education's *Science Education for the 1980s*. This document also provides a model for determining teacher effectiveness. The CAP

testing program provides one assessment of achievement and thinking skills for the individual school site. Elementary and secondary program reviews will assist local leaders in evaluating and improving science programs. There are also various local, regional, and national testing programs available that will report individual student progress. All of the above serve as yardsticks in measuring the success of a local science program.

OPERATING THE PROGRAM

Quality science instruction is evident to all the senses. It's not a program that is just heard; it is seen, felt, often smelled, and sometimes tasted. Science is a triad. First, it is a body of organized knowledge. It is facts, figures, concepts, and terminology. The knowledge manifests itself in the technical world—the application of science. Second, science is a way of solving problems, a way of discovering what is happening in nature, and a means of pushing back the cloak of ignorance. Science has been successful in solving many of the problems facing the human race as well as in adding to our understanding of the universe. Finally, science is people—people who work to seek the truth, people who through inspiration and perseverance push forward the human quest for knowledge. The science program in action must continually show all these sides of science.

Instructional Focus

Content is the foundation of a balanced science program. This content involves not only facts but techniques and strategies for thinking and exploring. As stated above, science education is a triad of concepts, processes, and people, but the methods and people of science are truly appreciated only when the science content is understood. Conceptual understanding cannot be fully realized without the texture added by conducting experiments, observing appropriate demonstrations, and discussing the societal implications of scientific and technological advances. Science education is predicated on students learning the

facts, laws, and theories of physical, life, and earth sciences.

The science curriculum should be based on current scientific knowledge and at the level of the student's emotional, physical, and intellectual development. Instruction in science will give experiences that reinforce the content learned in their classes, stimulate the development of investigative processes, and foster scientific inquiry and reasoning. Regular opportunities should be provided for students to explore natural phenomena, to apply science knowledge to current situations, and to develop a positive attitude toward self and science.

It is important to define the role of content in science instruction very carefully so that the outcome of our programs is students with a rich conceptual understanding of science.

Experiential Learning

While classroom activities should be diverse, varied, and exciting with a balance of science content and experiential learning, the instructional focus should be maintained on concepts acquisition.

A balanced science program is activity-based. Experiential learning is the acquisition of content and skills through active participation. An important aspect in all experiential learning is providing comprehensive safety instruction.

Students at all levels learn best by having activity-based, hands-on science experiences with an emphasis on developing the rational thinking skills inherent in scientific thinking. The student should experience the exciting and creative methods of study used in inquiry by professional scientists. The students can do this by replicating earlier experiments leading to the important discoveries in science, formulating experiments to solve specific problems of their own choosing, and developing alternative solutions to problems posed within the framework of the course content.

Attitudes, Ethics, and Values

Another important aspect of a science program is the open discussion of attitudes, ethics, and values. Students must come to realize that science is a human endeavor and not a value-free body of knowledge. Science and technology have such profound impact on society that ethics be an integral part of the science curriculum.

The *Science Framework Addendum* is quite explicit in its discussion of ethical issues in the classroom. The science curriculum should provide some opportunities for in-depth analysis of ethical issues, including understanding the consequences of various courses of action. It is desirable that the science program deal with ethical issues as they arise in the presentation of science.

It is important to note that when discussion is elicited on ethical issues, divergent and open-ended questions should be used and responses should provide clarification and expansion of students' views and opinions rather than evaluation and closure.

The province of science should be clearly understood. The science classroom should not be a forum for establishing points of view on the multitude of social issues, but rather it should be the basis for dealing with them. While science cannot dictate the conclusions to be made, it can provide a basis for seeking, understanding, and evaluating social issues that arise in the study of science.

Science Outside the School Setting

School districts should draw on and develop alliances with the science resources found outside the classroom. Universities, educational television, museums, zoos, field trips, and science fairs can play an important role in enriching the school science program.

There are abundant opportunities for parents to become an extension of the classroom by encouraging and providing science experiences for their children. The family can share in the enjoyment of providing science enrichment through travel, home activities, and involvement with homework.

Teachers can help parents (and their students) by assigning homework that extends the classroom assignment and encourages parent-student interaction on science topics.

Integration of Science Throughout Other Disciplines

All disciplines benefit by drawing on insights acquired in other fields of learning. Every curriculum area lends itself to the study of science and its applications just as science lends itself to the study of other curriculum areas. Examples include reading stories with scientific themes, using scientific articles as models for writing/language arts assignments, studying the mathematical aspects of scientific problems, discussing the ethical implications of specific social problems, and sketching various life forms to appreciate the similarities and differences in nature. One of the greatest achievements of science has been to establish connections between different aspects of culture and nature. These connections should be illuminated at every juncture in the teaching of science. Appendices I, II, and III are extremely helpful in relating science to literature, history, and our culture.

Application of Basic Skills in the Science Classroom

Instruction in science should assume a responsibility for teaching, reinforcing, and applying basic skills. Writing, oral communication, and computation are important components of science instruction. Students should learn how to read and interpret science articles and communicate scientific information orally; they must also apply appropriate mathematical concepts and computer skills in interpreting data. Students must learn and experience science as it relates to other areas if they are to make the transfer from conceptual learning to practical application.

BIOLOGICAL SCIENCE (K-3)

A. CELLS, GENETICS and EVOLUTION

1. DIFFERENCES EXIST BETWEEN LIVING AND NONLIVING THINGS; THERE IS GREAT DIVERSITY AMONG LIVING THINGS.

K-1

The teacher uses an aquarium to illustrate differences between living organisms (fish, algae, and snails) and nonliving objects (sand, rocks, bubbles, water). By observing and comparing, the students will determine characteristics of living and nonliving objects. Teachers focus the observations of the class on those items which distinguish the living from the nonliving (moving, respiring, etc.). Students will record characteristics by drawing, writing a story, and/or describing them to the teacher.⁴ Students will determine that all living organisms eat, breathe, move, reproduce, get rid of wastes, and react to stimuli. No nonliving object does all of these.

⁴Art, English-Language Arts (See page 2 for an explanation of entries like this one.)

2-3

Students will collect and display living, formerly living (shells, fossils, coal, bones), and never-living objects. After observing, discussing, and classifying the objects into the three categories, students will hypothesize whether certain objects are living. They will experiment to determine whether certain objects are living (plant seeds, gently prod the chrysalis of a butterfly) to prove or disprove their hypothesis. They will prove whether an object was formerly living by associating it with its living state. Students will reconcile their decisions with the criteria for living or formerly living organisms and never-living objects.

2. LIVING THINGS CAN BE DESCRIBED AND CLASSIFIED AS DIFFERENT KINDS OF PLANTS, ANIMALS, OR PROTISTS BY THEIR CHARACTERISTICS AND BEHAVIORS.

K-1

The teacher introduces categories and schemes for living things and shows pictures of living organisms with part of the organism covered. By inferring, students will name the organism and its characteristics and/or behaviors. For example, webbed feet indicate a swimming animal, plus a flat bill indicates a duck.

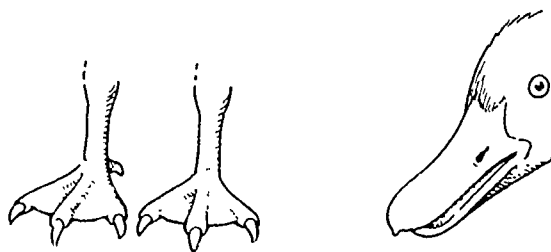

2-3

The teacher will distribute pictures of "mystery" organisms. By observing, teams of students will determine key characteristics and behaviors of their organism. Students will dramatize these so the class can name the organism.⁴ Students will recognize that all organisms have certain characteristics of structure, function, and behavior which enable people to classify them by identifying similarities, differences, and relationships.

⁴Art

3. MOST LIVING THINGS ARE MADE UP OF SMALLER STRUCTURES.

K-1

The teacher will collect and take apart various organisms (small plant to show root, stem, etc.; large fruit to show seeds, pulp, skin; cocoon to show chrysalis inside; insect to show wings, legs, etc.). By observing and describing, students will draw and label the parts of their organism, using a hand lens to aid observations of smaller structures.⁴

⁴Art

2-3

The teacher will trace the outline of several students on paper after providing diagrams and discussing the major internal organs. Teams of students will draw and label the internal organs in appropriate positions on the outline. The teacher will lead a discussion of organ systems and other structures of humans and have students relate them to structures of other organisms.

4. LIVING THINGS HAVE ADAPTATIONS THAT ENABLE THEM TO LIVE IN PARTICULAR ENVIRONMENTS.



K-1

The teacher will display pictures, mounts, and living specimens of similar (mouse and rat, garden snail and slug, sunflower and dandelion) and dissimilar (salamander and lizard, cactus and rose) organisms. By comparing structures and behaviors, students will identify adaptations, hypothesize what adaptation is for, and evaluate its effectiveness.

2-3

A small group of students will design an imaginary organism and another team determines the environment in which the organism lives. The two teams meet to evaluate how well the adaptations of the created organism fit the environment of the "species." Then the combined groups present the organism, environment, and any necessary adaptations.

5. A SPECIES IS COMPOSED OF SIMILAR INDIVIDUALS THAT REPRODUCE THEIR OWN KIND, BUT VARIATIONS EXIST AMONG THE INDIVIDUALS.

K-1

The teacher introduces the fact that while there is great diversity within organisms of a type (species), the common bond is that like produces like. Students will bring in pictures or species (like roses) and share similarities and differences within species. Then the teacher points out that despite the differences within a species, offspring of very different looking individuals do have common characteristics.

2-3

Humans, like other organisms, show great diversity within the species. Even in a single classroom, there are quite a number of differences that can be observed by comparing, measuring, and graphing.⁴ Students will record their height, hair and eye color, foot size, and fingerprints. They learn that despite these apparent differences, there is great commonality among humans.

⁴Mathematics

6. WHEN ORGANISMS DIE, THEIR LIFE FUNCTIONS CEASE AND THEIR BODIES DECOMPOSE.

K-1

Students will maintain a decomposition terrarium. On a school walk, they will collect dead and decomposing organisms (insects, plants) and decomposers and scavengers (sow bugs, earthworms, snails). These will be placed on loamy soil (not potting mix) in a terrarium, dampened slightly, and covered (but not kept airtight). Students will observe and record changes daily, keeping track of the decomposition process, how the environment changes (e.g., worms), etc.

2-3

The teacher and students will discuss death as cessation of bodily functions and decomposition as the recycling of materials of the original organism. At a time when a fish dies in the aquarium, the teacher will discuss the characteristics of dead organisms: no eating, respiring, moving, excreting, responding, etc. At this point, decomposition begins, and the teacher makes an analogy to composting done by gardeners.

7. FOSSIL REMAINS INDICATE THAT MANY SPECIES HAVE BECOME EXTINCT WHILE NEW SPECIES HAVE COME INTO BEING.

K-1

The teacher will relate the past existence of dinosaurs to extinct life forms. The teacher will display pictures of extinct animals (saber-toothed tigers, giant dragonflies, mammoths) and their living counterparts. By comparing these, students begin to understand the evolutionary relationships of extinct and existing animals.

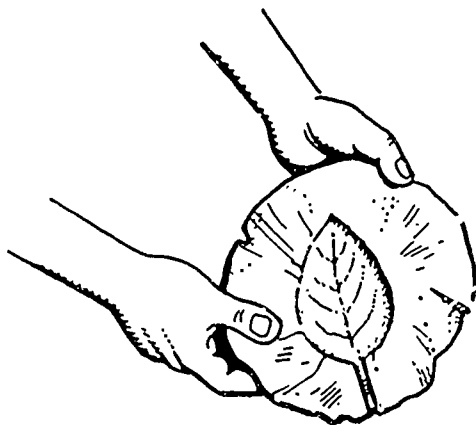

2-3

The teacher will have students learn the process of obtaining fossil evidence by having students enclose bones and leaves in plaster of Paris. After the plaster is thoroughly hardened, students will chip out the bones or leaves with a chisel. (SAFETY: Wear safety goggles.) With successes and failures, students will learn how archaeologists make fossil discoveries.

B. PLANTS

1. PLANTS HAVE BASIC REQUIREMENTS THAT NEED TO BE SATISFIED IN ORDER FOR THEM TO SURVIVE.

K-1

The teacher will introduce the necessary conditions for plant survival and demonstrate that experiments with plants can help improve success rate. The teacher will help students set up ten pots with the same species of plant (geraniums, beans, marigolds, etc.) in each. Students will then compare matched pairs of plants grown with and without light, water, warmth, drainage, and fertilizer. Growth rates are compared on a weekly basis, and students discuss the results related to each variable. Students will cooperatively design other experiments to test the basic needs of plants.

EXAMPLE GRAPH FOR FIRST WEEK

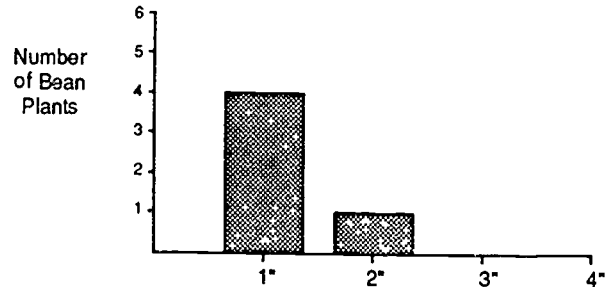

EXAMPLE GRAPH FOR SECOND WEEK

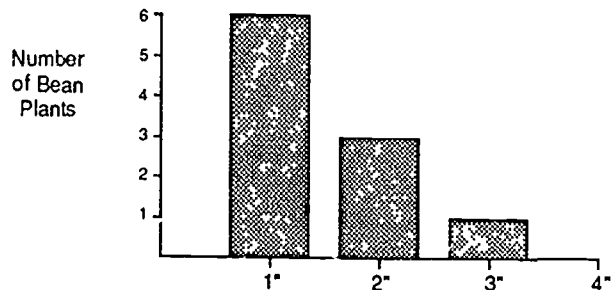

2-3

Students will grow young plants (beans, marigolds, tomatoes) in sand, loamy soil, shredded

paper, and other media. While giving normal care to plants, they will measure the growth of plants over a four-week period, recording data on histograms.⁴ After determining the best medium, they will grow plants in that medium and vary the amount of light, water, fertilizer, air (drained and undrained containers), and heat, using only one variable for each plant. Students will measure growth and record data on histograms. Students will determine basic and specific needs for plants.

⁴Mathematics

2. PLANTS HAVE MAJOR STRUCTURES THAT HAVE SPECIFIC FUNCTIONS.

K-1

The teacher will introduce the major plant structures (root, stem, leaves, flower, fruit, seeds) and their functions. Students will bring to class plant parts they eat and identify which structure each is. Students will use food sources to reinforce the commonalities and differences of plant structures.

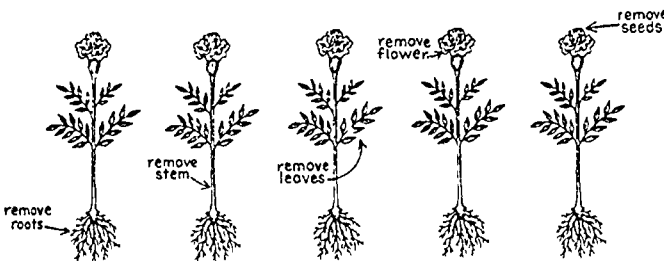

2-3

The teacher will bring in six growing plants of the same species (marigolds, radishes, etc.) and remove one structure from each (root, stem, all leaves, all flowers, all fruit or seeds). The students will predict the functions and then replant to continue growing the plants for one week. Students will then determine the functions of these parts from the results. The teacher will use a film or local resources to establish the structure and functions of plant parts.

3. SEEDS REQUIRE CERTAIN CONDITIONS IN ORDER TO GERMINATE; EACH SPECIES REPRODUCES ITS OWN KIND.

K-1

The teacher will bring in plants with seeds developing on them (wild mustard, radishes, marigolds, avocado on branch, pumpkin with part of vine).⁴ The teacher will help students to remove and plant ripe seeds and grow seedlings for several weeks. Students will compare the young plants to the original plants from which the seeds came.

⁴English-Language Arts

2-3

The teacher will set up three terraria, each containing mosses, ferns, "normal" plants, and a cactus. Students will give one a "desert" environment (heat, strong light, little water), one a "normal" environment, and one a moist, cool, shady environment. Students will observe and describe the results during a three-week period.

C. PROTISTS

1. PROTISTS CAN BE DESCRIBED AND CLASSIFIED AS ALGAE, FUNGI, OR PROTOZOA.

K-1

The teacher will introduce the differences of life forms that are too small to see, but readily available in pond life. The teacher (or students) will collect water and algae (pond scum) from a pond. Students will examine algae with a hand lens to observe bubbles of oxygen respired from green cells. They will examine drops of water under a microscope (or use films where there is no microprojector available) to observe protozoa and algae. The teacher will relate the existence of small living organisms that have a major impact on society, like yeast (for bread).

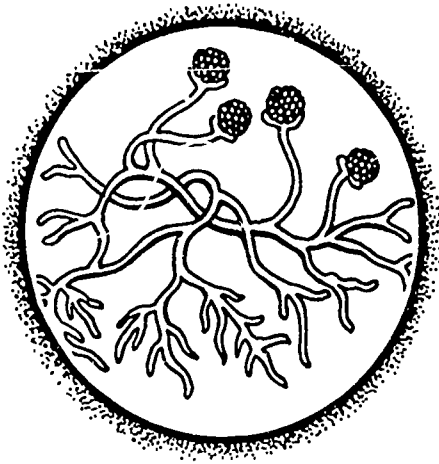

2-3

Students will examine yeast cells (dry activated yeast in water) and mold "threads" under a microscope.

The teacher will reinforce the diversity of life forms by having students collect specimens for a "protist zoo."

Students will collect various examples of algae (seaweed), fungi (yeast), and protozoa (amoebas) in order to understand the role of the protists in the web of life.

D. ANIMALS

1. THERE IS GREAT DIVERSITY AMONG ANIMALS; HOWEVER, ALL ANIMALS HAVE SIMILAR BASIC NEEDS.

K-1

The teacher will display pictures of a variety of animals (including invertebrates, such as jellyfish and sea stars, as well as a host of vertebrates) of various life forms and discuss their common needs: (1) food; (2) water; (3) habitat; (4) air (oxygen); and (5) temperature range. The teacher will reinforce the basic conditions of survival.

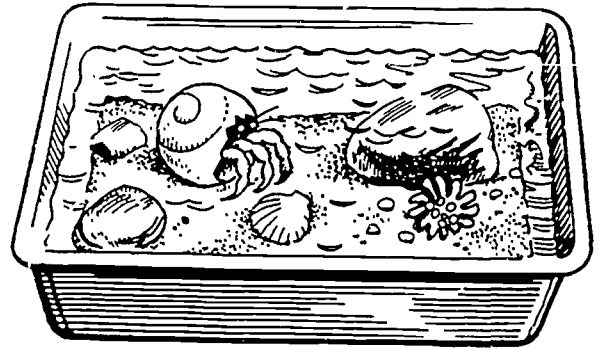

2-3

Each group of students will select an animal and then read,⁴ see films, and observe it if possible. Then they will make a diorama⁴ illustrating its habitat and needs. Students will determine basic needs of animals in general and then identify ways each species satisfies those needs.

⁴Art, English-Language Arts

2. ANIMALS CAN BE DESCRIBED AND CLASSIFIED BY THEIR STRUCTURAL AND/OR BEHAVIORAL CHARACTERISTICS.

K-1

The teacher will arrange a visit to the zoo (where possible) to help students see the array of animals that have common features. Some students will look for locomotion, others for habitat, and still others for skin covering, etc. In discussing their findings, the teacher will show that no one system is perfect and that big generalizations create classification anomalies.

2-3

The teacher will instruct the students about the five classes of vertebrates and ask students to bring in pictures of all five. They will arrange all the pictures into the five classes and decide whether the groups are arranged correctly to be

classified. Then they will draw two pictures of vertebrates and will be asked to classify them into one of the classes. Each student will be asked to support his or her answer.

3. ANIMALS PRODUCE THEIR OWN KIND; THEIR LIFE CYCLES ARE GENERALLY SIMILAR BUT VARY AMONG DIFFERENT KINDS OF ANIMALS.

K-1

The teacher will introduce the concept of growth and development and the stages leading to maturity for various animals. The teacher will maintain classroom animals which can give birth in the classroom: frogs, guppies, hamsters, chicks from fertile eggs, etc. The teacher will display pictures of young and adult stages of animals, or students can draw pictures of live specimens.⁴ Students will match young and parents.

2-3

The teacher and students will compare tadpoles, mealworms, or caterpillars (be sure to bring in food plants for caterpillars found outside). Students will record their observations by drawing⁴ stages of development and will distinguish between species that bear live young and egg layers.

⁴Art

E. HUMAN BEINGS

1. HUMAN BEINGS ARE MAMMALS WITH NEEDS AND FUNCTIONS SIMILAR TO THOSE OF OTHER MAMMALS AND WHICH CAN BE DESCRIBED BY CERTAIN CHARACTERISTICS AND BEHAVIORS.

K-1

The teacher will open the class with an overview of how humans are part of the animal kingdom,

comparing human needs with those of other mammals. The teacher will discuss characteristics and behaviors specific to humans (e.g., cooking food, wearing clothes, crying, using tools, playing musical instruments, writing and painting, reading books). Students will draw an 1/or collect pictures to make a collage showing human behaviors.⁴

⁴Art

2-3

The teacher will compare "primitive" (non-technological) societies with modern, technology-based society. Students will discuss, draw, and collect pictures of human behaviors and cultural variations (shelter, food, clothing, art, alphabets).⁴ Students will then relate these to needs that are basic to all humans and will group pictures according to class-developed categories.

⁴Art

F. ECOSYSTEMS

1. EACH KIND OF LIVING THING HAS SPECIAL NEEDS; IT GETS WHAT IT NEEDS FROM THE ENVIRONMENT AND INTERACTS WITH MANY OTHER LIVING THINGS.

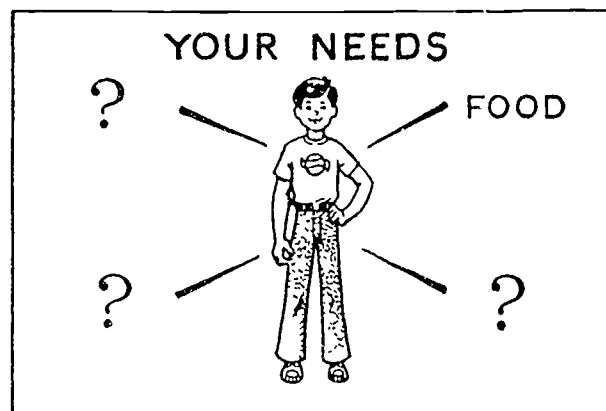

K-1

The teacher will begin a classroom mural with a picture of a person in the center. The students will list the needs of a person (food, clothes, house) in spokes around the figure after the teacher has completed one spoke. Then they will describe and draw sources of materials that satisfy the needs drawn around each spoke (webbing). The activity will be repeated for other organisms (trees, butterflies, birds). The teacher will then compare the relationships among organisms that have the same needs by demonstrating that each has the same figure in the same spoke.

2-3

Students will make a mural showing how various organisms obtain the same needed item (e.g., water for human, frog, kangaroo rat, caterpillar, aphid, radish, cactus, starfish). The teacher will help the students to develop a food web from a similar mural.

2. EACH KIND OF LIVING THING LIVES IN A SPECIAL PLACE CALLED ITS HABITAT AND SHARES ITS PARTICULAR ENVIRONMENT WITH OTHER LIVING THINGS TO FORM GROUPS CALLED COMMUNITIES IN SETTINGS CALLED ECOSYSTEMS.

K-1

The teacher will assign each student an organism to observe (pill bug, sparrow, worm) around the school yard. The students will describe, record, and draw their organism in respect to its habitat, shelter, and other plants and animals sharing the same locale.⁴

⁴Art

2-3

The teacher will provide each group of students with a wire coat hanger bent into a circle that will be used to circumscribe an area for field obser-

vation. Students will examine weed patches, observing and recording the number of different species within the wire circles and the number of individuals of each species. Names of various plants and animals can be invented by students.⁴

⁴English-Language Arts

3. ENERGY GOES FROM THE SUN TO GREEN PLANTS; ANIMALS GET ENERGY FROM EATING PLANTS AND/OR OTHER ANIMALS.

2-3

The teacher will discuss the flow of energy through the ecosystem. Students will trace the energy cycle from the sun to green plants and through the food chain to decaying organisms by taping actual specimens or pictures to a chart.

4. LIVING THINGS CHANGE WITH TIME.

K-1

The teacher will compare how people change over time. Students will display photos of grandparents as children, as young parents, and at present; their parents as children and at present; and themselves as babies.

2-3

The teacher will compare pictures of ancient forests (ferns and horsetails in the dinosaur era) to present-day forests. Students will record life cycle changes of a tree. (The teacher can grow an avocado, an oak, or a maple from seed or dig up and replant seedlings.)

EARTH SCIENCE (K-3)

A. ASTRONOMY

1. THE SUN IS OUR CLOSEST STAR. IT GIVES LIGHT AND HEAT; OTHER STARS ARE "SUNS" THAT ARE VERY FAR AWAY. GROUPS OR PATTERNS OF STARS ARE CALLED CONSTELLATIONS.

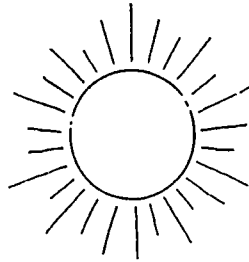

K-1

The teacher will compare a burning candle with the sun and a star. The teacher will burn the candle to illustrate that objects which give off light also give off heat. (SAFETY: A light bulb can cause burns.) The teacher will relate light and heat to light bulbs, hot plates, fire, etc.

2-3

The teacher will display pictures of several constellations. (The most prominent constellations are visible from November to March.) Students will randomly place about ten drops of ink on paper and make up their own constellations.⁴ The teacher will relate myths from various cultures about constellations. Students will make up their own myths about their constellations.⁴

⁴English-Language Arts, Art (See page 2 for an explanation of entries like this one.)

2. THE MOON REFLECTS SUNLIGHT. IT IS A NATURAL SATELLITE OF THE EARTH AND THE ONLY BODY IN THE SOLAR SYSTEM HUMAN BEINGS HAVE VISITED.

K-1

The teacher will describe the moon as a cold, rocky body reflecting light. Students will compare light reflection off white paper, a mirror, or other object to sunlight reflecting off the moon. The teacher will discuss that the moon is the only body in the solar system (besides earth) humans have visited.

2-3

The teacher will discuss the basic needs of living organisms, particularly human beings. Students will discuss what astronauts needed to stay alive on the moon and what would be needed to colonize the moon.^{1,4}

¹Carl Sagan

⁴Social Science

Free photographs and educational materials are available from NASA-Ames, Mountain View, CA 94035.

3. THE EARTH IS ONE OF NINE PLANETS REVOLVING AROUND THE SUN.

K-1

The teacher will display NASA photographs of planets taken by spacecraft, particularly those of earth. Students will compare appearances and discuss differences in temperatures and distances from the sun.

2-3

The teacher will present situations involving scale models, such as model airplanes and maps. The students will make a model of the solar system on the school yard by placing a stake on one side of the yard for the sun.¹ They will measure relative distances for planets (scale: 1 centimeter

per million kilometers or 1 inch per million miles) and place stakes for planets in appropriate places.⁴ The teacher will relate the distances to the time spacecraft require to travel and the average temperatures of each planet.

¹Copernicus

⁴Mathematics

4. THE SUN IS THE CENTER OF OUR SOLAR SYSTEM. THE EARTH REVOLVES AROUND THE SUN IN ONE YEAR AND ROTATES ON ITS OWN AXIS IN 24 HOURS, A MOTION THAT CAUSES NIGHT AND DAY.

K-1

The teacher will discuss yearly events and holidays and relate the time of one year to the earth traveling around the sun.

2-3

The teacher will set up a light bulb for the sun and darken the room. One student will carry the earth (a basketball) as he or she walks counter-clockwise around the sun while simultaneously turning the ball around on its own axis. Students will observe light and dark sides of the "earth." Students will observe (or mark on the ball) that California is first lit, passes opposite the "sun," moves away from the sun, and passes into darkness. The teacher will relate rotation to a 24-hour period and revolution around the sun to a one-year period, both occurring simultaneously.

5. AS THE EARTH ROTATES, THE SUN AND MOON APPEAR TO MOVE ACROSS THE SKY.

K-1

The teacher will help students compare the position of the sun (and moon when observable) to a fixed point at school (e.g., flagpole, roof) every half hour during the school day. Students will

record the position and time on a drawing of a fixed point. The teacher will demonstrate the need to observe from the same position each time to control variables.

2-3

The teacher will help students observe the position and angle of the sun in respect to the flagpole and relate the position to the length and position of the shadow. (SAFETY: Do not look directly at sun.) The students will mark the position of the end of the flagpole or other "pole" shadow every half hour throughout the school day. Students will draw a chalk line around the shadow, beginning at the top, and observe how quickly the shadow moves. The teacher will aid students to observe the position and phase of the moon and the time of observation and relate its motion to a fixed directional position of the sun during the year.

6. DAYLIGHT PERIODS ARE LONGER IN SUMMER AND SHORTER IN WINTER.

K-1

The teacher will prepare a recording sheet of clock faces. Students will record the time of sunrise and sunset during the winter months. They will record the time they have to turn lights on in the evening and the time it becomes too dark to play outside, and they will compare these times to daylight during the summer months (e.g., relate to favorite TV shows).

2-3

The teacher will help students observe changes in day length. Students will find information in the newspaper giving sunrise-sunset times, and compare day and night lengths weekly for several months. They will graph changes. The teacher will initiate discussions of energy conservation and relate them to daylight savings time.

B. GEOLOGY and NATURAL RESOURCES

1. THE EARTH'S SURFACE HAS A VARIETY OF TOPOGRAPHICAL FEATURES WHICH ARE CHANGED OVER TIME BY NATURE AND BY THE ACTIVITIES OF HUMAN BEINGS.

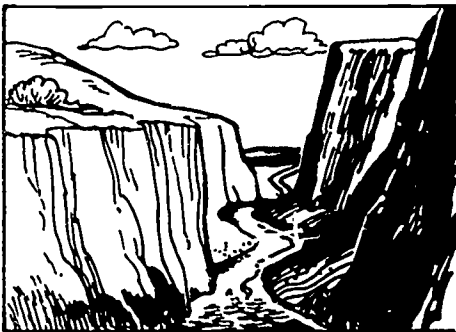

K-1

The teacher will discuss and show pictures of major topographical features such as river-cut canyons and mountains and compare their appearance and formation to local features. Students will take a walk to view local topographical features (e.g., erosion under downspouts of gutters, pathways worn through plantings and soil). The teacher will compare how local "miniature" features look to an ant or beetle.

2-3

The teacher will introduce vocabulary of geographical features. Students will make a salt/flour or clay topographic map modeling structures of geology (peninsula, mesa, delta, mountain range, river system).⁴ The teacher will aid

students in determining the best human use of structures (city, agriculture, open space, etc).

⁴Geography

2. ROCKS HAVE CHARACTERISTICS BY WHICH THEY CAN BE DESCRIBED AND CLASSIFIED; SOILS ARE FORMED FROM ROCKS.

K-1

The teacher and students will determine characteristics by which rocks can be classified. Students will collect rocks and classify them according to color, layering or crystals, texture, comparative weight, susceptibility to breaking, etc. The teacher will place rocks on a tray. One student will classify a specimen by describing its characteristics. Other students will try to pick it out.

2-3

The teacher will demonstrate weathering by: (1) shaking rocks together in a container until pieces break off; (2) soaking a piece of sandstone in water and then placing it in a plastic bag and freezing overnight; and (3) filling a small plastic bottle with pea or bean seeds, adding water to the brim, capping the bottle tightly, and leaving it in the classroom overnight. ("Root" or seed pressure will break the bottle or split the rocks.) Students will relate weathering of rocks to formation of soil particles. They will collect and examine different types of soil (sand, clay, loam).

3. EARTHQUAKES OCCUR WHEN BLOCKS OF EARTH MOVE; VOLCANIC ERUPTIONS OCCUR WHEN MAGMA (MELTED ROCK) IS FORCED THROUGH OPENINGS IN THE EARTH'S CRUST.

(SAFETY: Earthquake safety units are available from: Environmental Volunteers, Palo Alto; Lawrence Hall of Science, U.C., Berkeley; California State Department of Education,

Sacramento; U.S. Geological Survey, Menlo Park.)

K-1

The teacher will display and discuss pictures of mountains and valleys. Students will layer 1/4-in. (0.6-cm) thick strips of plasticene clay of different colors. They will push on the ends of the layers to observe a model of mountain building and earth movements. The teacher will emphasize the time frame needed to build mountains in respect to the amount of movement in one lifetime.



2-3

The teacher will display pictures and discuss volcanic activity from a U.S.G.S. educational unit on Mt. St. Helens. (SAFETY: Ammonium dichromate and powdered asbestos, as described in older source books, are hazardous chemicals and should not be used.) Students will compare pictures of Hawaiian volcanoes (shield) and Mt. Shasta (composite volcano) and make models of both types, the former with layers of thin plaster of Paris, the latter with thick plaster of Paris.

4. MANY OF THE NATURAL RESOURCES NEEDED BY HUMAN BEINGS AND OTHER LIVING THINGS ARE IN LIMITED SUPPLY.

K-1

The teacher will discuss and show pictures of both common and endangered species. Students will discuss effects of lack of habitat for organ-

isms and the need for parks and other wildlife preserves. The teacher will discuss "good manners" (such as staying on trails, leashing dogs, and not littering) in parks.

2-3

The teacher and students will determine natural resources needed by humans. Students will discuss the results of not having or running out of resources such as fossil fuels, pure water, clean air, wood, various minerals, and especially plants and ocean life. The teacher and students will discuss ways each student can conserve resources.

5. WEATHER PHENOMENA HAVE EFFECTS ON LIVING THINGS.

K-1

The teacher and students will determine components of weather. Students will record daily weather by placing on a flannel board pictures of types of clouds, flags and trees as they are angled by the wind, children dressed appropriately for that day, and corresponding terms (*hot, windy, rainy*). Students will draw pictures of or chart daily weather for a month.⁴ The teacher will read appropriate literature to introduce "weather words" from poems, etc. (*misty, damp, rainbow*), to add to pictures and charts.⁴

⁴Art, English-Language Arts

2-3

The teacher will bring in articles about current events related to weather phenomena (floods, drought, freezes).⁴ Students will relate weather phenomena to animal activities (hibernation, aestivation, insect metamorphosis, fur and feather color changes, migration).

⁴Social Science

6. AIR IS ALL AROUND US; WIND IS MOVING AIR WHOSE DIRECTION AND SPEED CAN BE MEASURED.

K-1

The teacher will define air as a substance we cannot see, but which is all around us. Students will become aware of air by: (1) blowing up a balloon and feeling the air come out; (2) using a fan to move air; and (3) placing a bottle underwater and seeing bubbles come out. Students will determine wind direction by relating it to the position of various school buildings, trees, and the flag's direction.

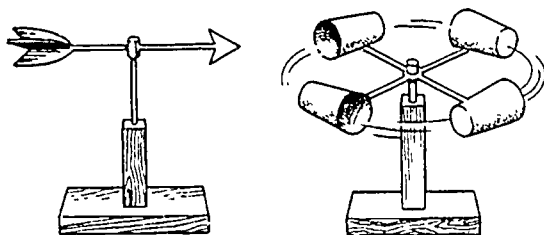

2-3

The teacher will introduce the use of an anemometer, a wind vane, and a directional compass. Students will determine and record wind direction and speed with a simple wind vane and an anemometer. They will relate direction to type of weather (south before rain, northwest after rain, east with very clear warm weather). Students will predict oncoming weather by determining wind direction. The teacher will match their predictions with the actual weather conditions.

7. THE SUN PROVIDES ENERGY FOR THE WATER CYCLE AND OTHER WEATHER PHENOMENA.

K-1

The teacher will ask students what happens to water on the ground from rain, etc. She or he will ask whether water disappears faster on a warm or cold day, in sun or shade. Students will measure the time required for evaporation in

shallow pans, containing the same amount of water, in the sun and shade. Students will observe water condensing in closed bottles placed in the sun and in the shade. The teacher will demonstrate "rain" by heating water in a covered Pyrex container and then letting the water cool and drip back into the container. She or he will relate this to rain from clouds.

2-3

The teacher will discuss evaporation of water when the temperature is warm, recondensation when the temperature of the water cools, and rain or snow falling. Students will draw simple diagrams of the water cycle, including water evaporating from small ponds, wet lawns and puddles, and formations of clouds. The teacher will discuss sources of water, after students examine world maps, and sources of energy to evaporate water.

8. CLOUDS HAVE CHARACTERISTICS BY WHICH THEY CAN BE DESCRIBED AND CLASSIFIED.

K-1

The teacher will have students observe different types of clouds during various weather patterns. Students will identify and describe the three major types of clouds. They will bring in pictures of clouds and classify them as to types. Students will discuss fears and feelings about lightning, thunder, and strong winds. Students will draw clouds and make up stories about cloud shapes.⁴

⁴Art, English-Language Arts

2-3

The teacher will have students observe clouds and bring in pictures containing various types of clouds. Students will classify clouds by three major types and common subtypes and relate types to cloud height and particular weather patterns. The teacher will "make lightning" by

rubbing pieces of nylon or polyester cloth in a dark room (static electricity). The teacher will "make thunder" by shooting off a wooden "pop gun" or pulling a "plumber's friend" off a surface. The teacher will read myths about the causes of lightning and thunder.⁴

(SAFETY: Discuss safety procedures during a lightning storm, especially when caught outside or in a car.)

⁴Social Science

C. OCEANOGRAPHY and HYDROLOGY

1. NEARLY THREE-QUARTERS OF THE EARTH'S SURFACE IS COVERED BY WATER, BUT MOST OF THE WATER IS SALTY.

K-1

The teacher will make a 3.5 percent salt solution (2-1/3 tablespoons salt in 1 quart of water; 35 mL in 1 L) and have students taste "seawater." Students will examine maps and globes to compare land and water coverage of the earth.⁴ The teacher will discuss limited sources of fresh water and the need for conservation. Students will identify all places where water can be found and whether the water is fresh or salt water.

⁴Social Science, Geography

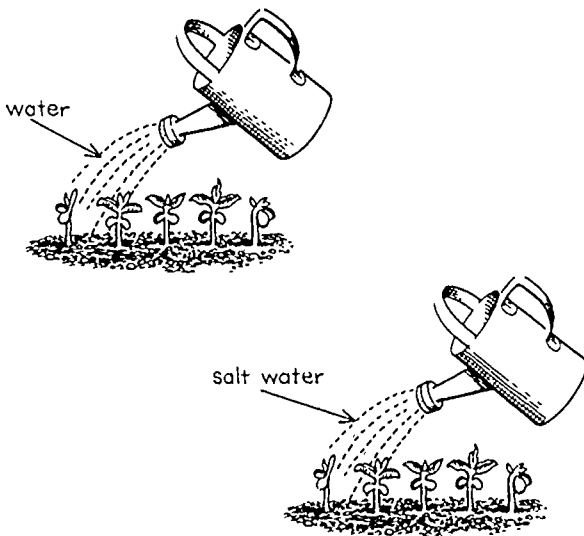

2-3

Students will water corn or bean and beet plants for 3 weeks with fresh water and 1 percent, 2 percent, and 3.5 percent saltwater solutions and measure and graph growth. (Add 1 teaspoon salt to 2 cups of water for a 1 percent salt solution; 5 mL to 0.5 L). The teacher will discuss sources of water for agriculture.

2. THE OCEAN IS THE MAJOR CONTRIBUTOR TO THE WATER CYCLE.

K-1

The teacher will heat salt water in a covered container. Students will taste the water condensed on a lid and relate fresh condensed water on the lid to the water cycle.

2-3

The teacher will display a sequence of weather satellite photographs to demonstrate clouds over oceans and cloud movement. Students will discuss fog formations when wet areas become cool (coastal fog, "tule" fog) and the role of trees, etc., as "water traps" for fog condensation.

3. THE OCEAN BOTTOM HAS MANY TOPOGRAPHIC FEATURES COMPARABLE TO LAND SURFACES.

K-1

The teacher will show pictures taken of the ocean floor, especially near land. Students will make a plasticene clay or plaster of Paris model of the land area with hills and valleys in a large, deep pan. They will slowly fill the pan with water to observe formation of lakes, islands, shorelines, etc. Students will draw pictures of undersea features, discuss a submarine trip on the ocean floor, and compare it to the formation before it became inundated.⁴ The teacher will compare the model to a reservoir before and after flooding.

⁴Art

2-3

The teacher will discuss navigable waters in respect to sizes of ships and boats that can use them. Students will examine maps of harbors to determine deep and shallow areas and topographical maps of the ocean floor to determine undersea mountain ridges, islands, etc. They will relate the topography to boat and ship drafts, inland harbors (Sacramento and Stockton), and undersea explorations by submarine submersibles.⁴

⁴Social Studies, Geography

4. THE SEA CONTAINS AN IMMENSE VARIETY OF LIVING THINGS.

K-1

The teacher will list all organisms students name that are found in the ocean. Students will collect pictures and/or watch films or videos for tidepool and ocean-oriented programs. The teacher will keep adding to the list of organisms and point out the variety of shapes, colors, relationships, adaptations, etc., that are found.

2-3

The teacher will display a variety of sea life, both pictures and specimens, and encourage students to bring in shell collections, etc. Students will identify various marine invertebrates and describe their adaptations. Students will draw and describe the life cycles of several major groups of marine invertebrates.⁴ The teacher will discuss variety in organisms and even among mollusks (shelled animals) alone.

⁴Art

5. THE OCEAN PROVIDES MANY NATURAL RESOURCES FOR HUMAN BEINGS.

K-3

The teacher will display pictures of resources from the ocean and encourage additions from

students. Students will discuss resources from the ocean: food, medicines, minerals, transportation, aquaculture, undersea oil drilling and mining, and recreation. The teacher will bring to class appropriate news articles about current events related to the ocean's resources, including information about foods various cultural groups get from the ocean.⁴

⁴Social Science

2-3

The teacher will display pictures illustrating ocean pollution by oil spills (oil-soaked birds), sewage (beaches closed to swimming and fishing), and shoreline development (beaches closed to the public). Students will discuss the steps the public (parents) and government take to prevent pollution and steps students can take to avoid littering at beaches.

6. MANY LIVING THINGS NEED FRESH, PURE WATER; RAIN AND SNOW RUNNING INTO RIVERS AND LAKES ARE THE MAIN SOURCES OF FRESH WATER.

K-1

Students will compare the environments of ocean and freshwater plants and animals.

2-3

The teacher will bring to class five each of live plants from sunny-hot-dry to "normal" to shady-cool-moist types of climates. Students will grow these under proper conditions but will water one of each kind with clean water, oily water, soapy dishwater, water with liquid bleach (concentration for removing stains), and vinegar (half vinegar and half water). Students will observe native plants of the home area and compare their characteristics to those of plants of different climates.⁴ Students will determine adaptations of desert animals to drought conditions.

⁴Geography

PHYSICAL SCIENCE (K-3)

A. MATTER

1. MATERIALS AND OBJECTS HAVE CHARACTERISTICS BY WHICH THEY CAN BE DESCRIBED AND CLASSIFIED.

K-1

The teacher will provide objects to classify for sensory perceptions, physical characteristics, and function. Using all their senses, students will classify a set of objects as to size, shape, color, sound, relative position, smell, weight, texture, and form. Students will classify objects through experimentation as to buoyancy, magnetism, elasticity, change in shape or form, and hardness. Students will also classify objects as to their functions. The teacher will select some classified objects and ask students to explain their reasons for classification.

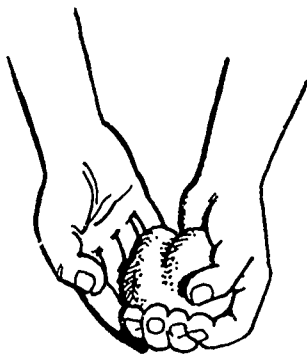

2-3

The teacher will provide beeswax for students to shape with their hands and paraffin for other experiments. The students will identify the characteristics of beeswax and paraffin as to whether or not they can change state or shape, be burned for light or heat, float or sink, and mix with water. Students will experiment with the water repellent characteristics of wax by making wax paper, furniture polish, and batik-cloth.⁴ The teacher will make a chart listing the characteristics of wax and comparing them to those of oils, water, and ice.

(SAFETY: Melt paraffin or wax in a container placed in water and heat the water. Never melt these materials directly over heat; wax vapor may explode.)

⁴Art (See page 2 for an explanation of entries like this one.)

2. MATTER EXISTS AS A SOLID, LIQUID, OR GAS AND CHANGES STATE WITH THE ADDITION OR LOSS OF HEAT.

K-1

The teacher will demonstrate the change of state of water from ice to liquid to steam and back to liquid and ice. The teacher will melt and resolidify sugar and demonstrate dry ice melting. Students will dip a frozen banana in melted chocolate and observe the change of state of the chocolate. The teacher will relate cold to solid state, warm to liquid, and hot to gas.

(SAFETY: Boiling water, steam, and melted sugar can inflict severe burns; dry ice can cause tissue damage.)

2-3

The teacher will elicit from students the names of common materials which are solid, liquid, or gas at room temperature and discuss what temperatures are necessary to change their states. Students will add ice to liquid butyl stearate,* record the temperature and rate at which it solidifies, and compare this result to the characteristics of water. Students will make lipstick or "chapstick" out of the butyl stearate by adding Crayolas** for coloring and wax (not paraffin) for hardening. The teacher will demonstrate the freezing (solidifying) and melting temperatures of water, chocolate, and sugar and compare them.

* Available from any chemical supply service.

** Crayola brand crayons will melt in wax; other brands may not. Crayolas are nontoxic.

B. MECHANICS

1. OBJECTS CAN BE DESCRIBED, SEQUENCED, AND/OR CLASSIFIED IN RESPECT TO THEIR POSITION, DISTANCE, MOTION, AND TIME OF OCCURRENCE.



K-1

The teacher will have students run a race and then call "freeze!" about half way through the race. Students will describe their own position in respect to that of others. Students will place a chart of the positions on the chalkboard. The teacher will have each student select a printed word to describe his or her position in relation to those of others (e.g., first, half way, slow).

2-3

The teacher will map the classroom or other area by helping students place a 1 meter square grid of strings across it, number each square, and then place a sheet of paper on the floor with a grid drawn to scale: 1 m = 10 cm. Students will duplicate the map on a smaller scale with blocks.⁴

⁴Social Studies, Geography

2. ENERGY IS NECESSARY TO DO WORK; MACHINES MAKE SOME WORK EASIER.

K-1

The teacher will define a machine as an object that makes work easier. Students will compare and discuss trying to lift a heavy box off the floor directly and then raising it with a lever. Students will slide a heavy box across the floor, and then compare this movement with placing the box on casters and rolling it. They will spin a book on a table and then place 15 to 20 marbles under the lid of a large jar, lay a book on the lid, and spin again. They will then compare the two spinings. The teacher will discuss the amount of force necessary to accomplish the work of moving the object and the energy needed to do the work.

2-3

The teacher will have students lift heavy objects with a lever and then pose the problem of lifting them higher off the ground. The teacher will characterize pulleys as "bent" levers. The students will use fixed and movable pulleys to raise heavy objects and determine their relative mechanical advantages. The teacher will borrow large levers (such as those used in piano moving) and have students lift a large, heavy object or observe an engine being hoisted out of an automobile.¹

¹Archimedes

3. A FORCE IS A PUSH OR A PULL AND IS NECESSARY TO MOVE AN OBJECT OR STOP AN OBJECT IN MOTION.

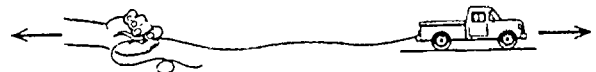

K-1

The teacher will demonstrate on a child in a swing that force is necessary both to set the swing in motion and to stop the moving swing.

Students will use the force of a push or pull to move a stationary object. Students will stop a moving object by using a pulling force on it (attach a string and pull on the string as the object moves away). Two students will sit on the floor, place the palms of their hands together, and push. Then they will interlock their fingers and pull. Next, they will lie on their backs on the floor under a small table and raise the table with their legs. The teacher will discuss the feeling of muscles in using force to cause motion and other types of force: air pressure, water pressure, gravity, and machines and their energy sources.

2-3

The teacher will place 16 1-gallon (3.8-L) plastic freezer bags around a table, five bags to a side, and open the ends outward. She or he will lay another table upside down on the first table. On the first table, the teacher will leave the open ends of the bags exposed about 2 in. (5 cm). Sixteen children will blow into the bags and raise the table. The teacher or another student can sit on the table before students begin blowing. The force of the air pressure will easily raise the table with the person on it. The teacher will relate the force of air pressure to jack hammers, spray paint containers, and barometers.

4. GRAVITY IS THE FORCE THAT ATTRACTS OBJECTS TO THE CENTER OF THE EARTH.

K-1

The teacher will hold various objects, some obviously heavy and others light, and ask what will happen if she or he drops them. Students will predict what will happen. They will predict what will happen when they release objects on an inclined plane, in water, and in a 10 percent salt solution and then experiment with releasing the objects. Students will predict what will happen when they throw objects vertically and then horizontally. Students will discuss what would happen if there were no gravity (weightlessness

in space; loss of air, oceans, soil; loose objects drifting away). The teacher will bring in pictures of weightless conditions inside spaceships.

2-3

The teacher will discuss gravity as a force and set up experiments to measure the force of gravity.¹ Students will attach a large rubber band to a small block or box. They will pull the rubber band to unstretched length, measure it, and then measure the additional stretch needed to move the toy. Students will repeat the activity, pulling the toy up an inclined plane raised to various angles and then down an inclined plane, measuring the rubber band's stretch. Students will add weights to the box and repeat the measurement with each addition. They will lift the empty box vertically and measure the stretch. After using the rubber band, students can repeat the activity with a simple spring scale. Students will predict changes in the rubber band's stretch and relate changes to weight and angle of lift. The teacher will set up a table to record data and compare the amounts of force needed to do the work.

¹Galileo, Newton

C. ENERGY: SOURCES and TRANSFORMATION

1. ENERGY IS NECESSARY TO DO WORK AND CAUSE CHANGES IN MATTER; ANY KIND OF CHANGE REQUIRES ENERGY.

2-3

Students will move objects from one place to another and identify the source of energy. Students will melt margarine over a candle; move an object with a magnet; pour vinegar on baking soda; mix plaster of Paris with water (feel heat given off); and wind up a spring to make a toy "go." Students will make a bulletin board to show energy being used to do work and make changes.

2. ENERGY EXISTS IN SEVERAL FORMS, INCLUDING HEAT, LIGHT, ELECTRICITY, MAGNETISM, CHEMICAL ENERGY, NUCLEAR ENERGY, AND MOTION; THE SUN IS OUR PRIMARY SOURCE OF ENERGY.

2-3

The teacher will discuss energy as something in an object that enables it to do work and identify forms of energy. Students will make a variety of objects that operate by using different rubber band-powered wind-up toys (first "muscle power," then motion); a lemon juice battery to light a flashlight (electrical); a vinegar and baking soda rocket (chemical); a magnetic maze game (moving metal objects through a game board with a magnet); a pinwheel spinning over a candle (heat moving air, motion of air); popping corn (heat). Students will make a mural to trace an energy form to its source.

D. HEAT

1. HEAT COMES FROM A VARIETY OF SOURCES, INCLUDING THE SUN, FIRE, LIGHT, AND FRICTION.

K-1

The teacher will display a bulletin board with pictures containing heat sources. Students will identify heat sources. Students will feel the pavement and other objects in the sun and in the shade. Students will feel lit and unlit light bulbs. (SAFETY: A lit bulb can burn.) Students will rub their hands together, rub two blocks together, etc., to feel heat from friction. Students will exercise and then take their temperatures to determine heat from metabolic activities of living organisms. The teacher will discuss myths about how human beings discovered fire.

2-3

The teacher will discuss how some objects give off heat that can be used by people, but that

the amount of heat varies, depending on source and distance. Students will use a thermometer to measure and compare temperatures at varying distances from heat sources, such as a candle, light bulb, hot plate, and objects such as a sidewalk in sun and shade. The teacher will discuss the Greek myth of Icarus and Daedalus and discuss means of preventing wings from melting.⁴

⁴History-Social Science

2. HEAT IS ESSENTIAL FOR LIVING THINGS, BUT TOO MUCH OR TOO LITTLE HEAT CAN CAUSE DAMAGE.

Strips of paper illustrate the height bread rises.

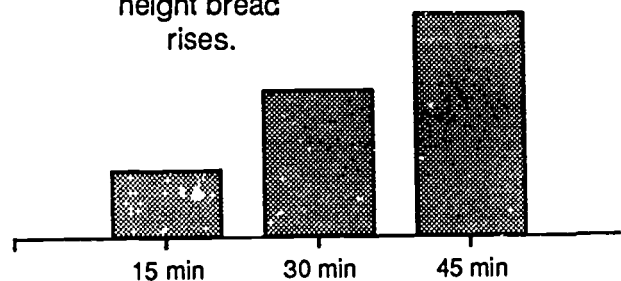

K-1

The teacher will describe briefly that yeast, which makes dough rise, is actually composed of microscopic plants that need warmth to grow. Students will make or purchase bread dough and let it rise under "too cool" (65°-70° F; 18°-21° C), "too warm" (95°-100° F; 35°-38° C), and correct conditions (about 80° F; 27° C). The teacher will help the students measure the amount bread rises, plot the rise against time (every 15 minutes), and examine the dough.

2-3

The teacher will discuss the effects of improper storage of food and food spoilage. Students will compare the effects of different temperatures (near a heater, in a room, in a refrigerator or

freezer) on the storage of food (broccoli, head lettuce, milk, bananas, peanut butter) and graph the results. The teacher will collect and discuss information about the proper storage temperature for different foods.⁴

⁴Health

3. TEMPERATURE IS THE MEASURE OF HOW HOT THINGS ARE.

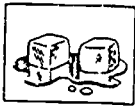

K-1

The teacher will pass around various objects of different temperatures and ask students to sequence them from coldest to warmest. Students will sequence a series of pictures (swimming pool, ice cubes, frying bacon, burning candle, bottle) from coolest temperature to hottest. Students will compare ice from a refrigerator freezer and ice from a storage freezer by feel. (SAFETY: Storage freezer ice can cause tissue damage if held too long or placed in the mouth.) The teacher will define temperature as the way the amount of heat in an object is measured.

2-3

The teacher will discuss that objects expand when heated, which is the basis for a thermometer. Students will make and calibrate a water thermometer. They will place a 24-inch (61-cm) glass tube into a two-holed rubber stopper and place a thermometer into the second hole, to the same bottom level. They will half-fill a 1-cup (0.24-L) flask or bottle with water colored with food coloring and place a stopper tightly in the bottle. Students will warm the the bottle (in hands) or cool it to change the water level in the tube. The teacher will aid students in calibrating by marking water levels on the glass tube to correspond with thermometer readings.

E. LIGHT

1. LIGHT COMES FROM A VARIETY OF SOURCES AND HAS CHARACTERISTICS BY WHICH IT CAN BE DESCRIBED AND CLASSIFIED.

K-1

The teacher will demonstrate a variety of light sources (glowing hot plate, burning wood, Coleman lantern, candle, flashlight, light bulb, sparks from fire starter, photographs of lightning and aurora borealis, photographs of lightning bugs and light-producing deep sea fish).

(SAFETY: Use caution when demonstrating hot or very bright light sources.) Students will describe characteristics of light from various sources by intensity, color, heat, etc.

2-3

The teacher will demonstrate that light travels in all directions by turning on a light bulb in a darkened room. Students will recognize that light travels in straight lines by placing a cardboard box over a light bulb in a darkened room and poking small holes one by one in the top and sides of the box. The teacher can make light rays more easily seen by shaking chalk dust into the rays and relating the dispersion of light to that of dust particles, etc., in the air.

2. LIGHT CAN TRAVEL THROUGH SOME MATERIALS; MATERIALS THAT BLOCK LIGHT CAST SHADOWS.

K-1

The teacher will display a variety of materials—transparent, translucent, and opaque. Students will predict which of the materials will cast shadows and hold each in a light beam to verify their predictions. Students will relate the degree

of transparency of material to color and density of shadow.

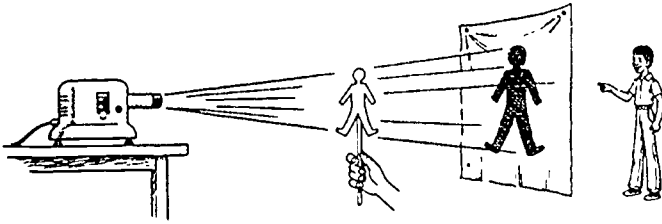

2-3

The teacher will demonstrate making silhouettes on paper, using a projector beam as the light source. Students will make stick puppets (cut out shape and glue to thin rod), project shadows with the projector beam on a screen (white cloth sheet), and put on a shadow play. Students can make colored "shadows" by using transparent colored plastic for puppets.⁴

⁴Art

3. LIGHT TRAVELS IN STRAIGHT LINES BUT CAN BE REFLECTED.

K-1

The teacher will identify and describe reflective surfaces around the classroom and school yard. Students will experiment with a variety of materials and identify those which reflect light. Students will reflect light from metal mirrors or other reflective surfaces onto various "targets" in the room. (SAFETY: Students must not reflect light, especially sunlight, into another person's eyes.)

2-3

The teacher will challenge students to make light rays bend around objects and corners to illustrate the concept. The teacher will help students determine lines between the light source, reflective surface, and lighted "target." Students will determine where they must position themselves in front of a large mirror in order to see various

objects reflected in the mirror. Students will run strings between themselves, the mirrors, and the object. The teacher will clarify that angle of light from the mirror. (Angle incidence equals angle reflection.)

4. VERY HOT OBJECTS RADIATE LIGHT AS WELL AS HEAT.

K-1

The teacher will heat a needle or thin wire in a candle flame until it glows red and darken the room to observe light emission. The teacher will demonstrate the glow of a blown-out match or piece of charcoal. Students will hold their hands close enough to the glowing object to feel heat, observe the distance at which they can see light, and compare distances.

2-3

The teacher will demonstrate that lenses concentrate light by having students look through a magnifying lens and field glasses. Students will focus sunlight on paper through a magnifying lens until the paper begins to char. (SAFETY: Perform under teacher's supervision only.) Students will repeat the experiment, but use classroom light as the source of radiant energy. Students will relate the radiant energy of light to the heat of a nearby star (like our sun) and light from stars which are too far away to have heat felt.

F. ELECTRICITY and MAGNETISM

1. MAGNETS ATTRACT OBJECTS CONTAINING IRON AND CAN BE USED TO SORT MATERIALS.

K-1

The teacher will display a tray of objects, some containing iron and some, like aluminum, not containing iron. Students will use a magnet on a

fishing rod to "fish" for objects in a large container. They will compare the objects attracted with those not attracted. They will predict which objects from another set will be attracted to the magnet. The teacher will discuss characteristics of objects able to be attracted.

2-3

The teacher will prepare a mixture of iron filings and sand and ask students to pick out iron with tweezers. Then, students will sort out iron filings from the mixture by running a magnet through the mixture. Students will pick up steel pins from a mixture of steel and brass straight pins in a container. The teacher will discuss industrial uses of magnets (sorting metals in a resource center, lifting cars in an auto junkyard).

2. MAGNETS HAVE TWO POLES, NORTH AND SOUTH. OPPOSITE POLES ATTRACT; LIKE POLES REPEL EACH OTHER. MAGNETIC FORCE OPERATES THROUGH MATERIALS AND OVER A DISTANCE.

K-1

The teacher will provide magnets for students to determine properties. Students will hold bar or cow* magnets together and experiment with attracting and repelling forces. The students will "push" one magnet across a surface with another by placing like poles together. The students will move iron objects on a surface (paper, water, wood) by moving a magnet below the surface to demonstrate that magnetic force works through a separating object and through space. The teacher will elicit a list of properties of magnets from students.

*Long-lasting cow magnets can be obtained from agricultural supply houses.

2-3

The teacher will discuss that magnets can attract and repel through space. Students will stack "doughnut" magnets (circular with a hole in the

center) on a wooden dowel. They will place magnets with like poles adjacent so that repelling forces leave spaces between the magnets. Students will tie a 10-cm thread through a magnet and tape the loose end to desk. Then students will lower an iron rod (such as a file) toward a magnet until it rises and "floats" under the rod. The teacher will suspend the magnet and approach it with the like pole of another magnet. She or he will ask students to explain the action of the tethered magnet.

3. OBJECTS CONTAINING IRON CAN BE MAGNETIZED; MAGNETISM CAN BE TRANSFERRED TO OBJECTS CONTAINING IRON.

K-1

The teacher will refer to magnetism operating through space and other materials and ask students to hypothesize whether it can be transferred. Students will suspend a series of objects (paper clips) from a magnet, each hanging from the preceding one, to demonstrate that magnetism can be transmitted. The students will compare how far a series of magnets can transmit magnetism by determining how many paper clips, each hanging from the preceding one, can be lifted. Students will compare the relative strength of various magnets and sequence them according to how many paper clips each can lift.

2-3

The teacher will discuss that magnets can be made and destroyed. Students will make a magnet by stroking a small iron nail or a needle with a strong bar magnet 20 to 30 times in the same direction. They will use the magnetized nail to pick up small iron objects. Students will hit the magnetized nail or a small magnet with a hammer and try to pick up iron objects to demonstrate that magnetism also can be destroyed.

4. MATERIALS CAN BE DESCRIBED AND CLASSIFIED ACCORDING TO WHETHER OR NOT THEY CONDUCT ELECTRICITY.

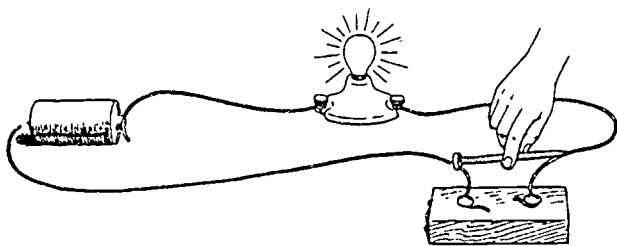

2-3

The teacher will set up a circuit with a D cell battery, a flashlight bulb set in a porcelain or plastic socket, and each wire end wrapped around separate steel thumbtacks set about 1 in. (2.5 cm) apart in a block of wood to provide an open circuit. Students will bridge the gap (close the circuit) between thumbtacks with various materials to determine whether materials conduct electricity (copper or steel wire; brass, iron, and aluminum nails; aluminum foil; dry string and string soaked in vinegar; coin; any other object of plastic, wood, etc.).¹ (SAFETY: There is no possibility of a student receiving a shock or other injury from handling the circuit setup.) The students will predict, then experiment with a test set of objects, their conductivity. The students can compare and sequence the ability of various objects to conduct electricity according to the brightness of the flashlight bulb. The teacher will elicit a list of materials able to conduct electricity and nonconductors. Students will compare properties of materials that conduct electricity.

¹Franklin

5. ELECTRICITY IS AN ENERGY SOURCE USED TO RUN MACHINES AND PROVIDE LIGHT AND HEAT.

K-1

The teacher will discuss energy sources (wind, water, sun, etc.) and focus on electricity as a

form of energy. Students will make a list of all objects run by electricity in their homes.² They will categorize them by function (heat, light, motor to make objects "go"). Students will make a shoebox model of a house. They will draw in electrically powered objects in appropriate places. Students will discuss and practice conservation by turning off electric lights and appliances when not in use.

²Electricity

2-3

The teacher will discuss the concept that any resistance to the flow of electrical current produces heat. Students will make a circuit with a 6 V battery and fasten the two wires into two clean, 3-in. (7.6-cm) steel nails. They will place one nail into each end of a hot dog and, using it as a resistor, cook it. Students will relate the heat to cook a hot dog to the heat given off by other resistors (e.g., electric light bulb, electric hot plate).

G. SOUND

1. SOUNDS COME FROM MANY SOURCES. CAN TRAVEL THROUGH MANY THINGS, AND CAN BE REFLECTED OR ABSORBED BY VARIOUS SURFACES.

K-1

The teacher will tape-record sounds the students hear while the class takes a walk. Students will identify sounds played back after the walk. Students will make a mural of the walk and draw in the objects that made the sounds.⁴

⁴Art

2-3

The teacher will place a box over a transistor radio while the students listen to the sound. She

or he will line the box with insulating material (cotton batting, egg cartons) and place it over the radio. The teacher will place a Masonite or metal screen behind the radio, directing the sound in one direction, or place a megaphone in front of the speaker. Students will compare and describe sounds and compare insulating and reflecting materials and surfaces.

2. SOUNDS HAVE CHARACTERISTICS BY WHICH THEY CAN BE DESCRIBED AND CLASSIFIED.

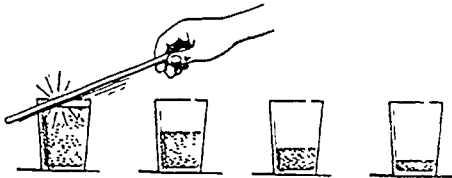

K-1

The teacher will demonstrate how sounds made by similar objects (bells, xylophone, etc.) will have a different pitch and can have a different intensity. Students will fill the same size and shaped bottles or water glasses with varying amounts of water, strike the bottles with a metal rod, and compare and sequence the bottles according to pitch (or frequency) of sound. Students will strike the bottles with varying amounts of force to compare intensity (or amplitude) of sound.

2-3

Using the bottles in the above activity, the teacher will help students to set up water-filled bottles in a sequence. Students will experiment by varying the amount of water so as to "tune" the bottles to the scale of a piano or guitar. The students will play simple melodies on the bottles.⁴

⁴Music

3. VIBRATING OBJECTS PRODUCE SOUND; THEY CAUSE VIBRATION IN WHATEVER THEY TOUCH, INCLUDING THE EARDRUM.

K-1

The teacher will discuss that objects that vibrate rapidly produce sound. Students will make a soundscope to observe vibrations. They will cut both ends off a long, narrow can (tennis ball can) and make a drumhead by fastening a stretched balloon over one end. Then the students glue a piece of mirror off center on the balloon. While standing so the mirror reflects light on the wall, they will speak into the opposite end of the tube and watch the reflected light vibrate. The teacher will discuss what made the balloon vibrate.

2-3

The teacher will relate the pitch of a flute or recorder to water-filled glasses. The students will gently flatten the end of a plastic straw and cut from both sides to form two overlying triangles or double points. They will press their lips together just beyond the cuts for a "double reed"⁴ and blow. They will cut a series of straws, each shorter than the preceding one, to form a "pan pipe," or cut a series of small holes half an inch apart in one straw for a "flute."⁴ The teacher can tune the pan pipes to a piano as students experiment with the correct lengths of the straws.

⁴Music

BIOLOGICAL SCIENCE (4-6)

A. CELLS, GENETICS, and EVOLUTION

1. LIVING THINGS ARE MADE UP OF A CELL OR CELLS. MOST CELLS HAVE A NUCLEUS, AN OUTER COATING, AND OTHER STRUCTURES.



- Show microscopic views of plant and animal cells using an overhead projector or a microprojector; identify and compare their structural parts. Then ask students to make a simple human cell model by filling a small twist top Baggie with colored water, Jell-O, gelatin, or styling gel. Insert an item such as an olive or button to represent the nucleus; smaller items may represent cytoplasmic structures, such as mitochondria. A plant cell may be modeled by adding a cardboard cell wall and chloroplasts. Ask students to describe the three-dimensional shape of cells as well as the parts of a typical human body cell.^{1,2}

¹Leeuwenhoek

²Cell Theory (See page 2 for an explanation of entries like these.)

- Explain to students that groups of similar specialized cells form tissues, tissues form organs, and organs are grouped into systems that perform functions in complex organisms such as humans. Ask groups of students to attach several similar Baggies together to form a model of a tissue. Different student groups may vary the size, shape, color, and consistency of liquid in the Baggies to represent different type cells resulting in different tissue types. Encour-

age the class to build a complex "organism" with tissues, organs, and systems. Discuss the interrelationships of systems within the human body (i.e., circulation-respiration; muscular-nervous; etc.).¹

¹Harvey

2. GENES ARE MATERIALS IN CELL NUCLEI THAT DETERMINE THE CHARACTERISTICS OF ORGANISMS AND ARE LOCATED IN THE CHROMOSOMES.

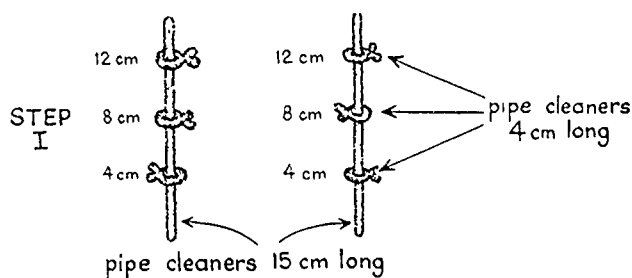

STEP II Wind the pipe cleaners together to form a simplified chromosome model.

- Discuss the nucleus as the control center of the cell; then describe the structure and function of chromosomes. Give each student two similarly colored 15-cm (about 6-in.) pipe cleaners and six 3-cm (about 1.2-in.) pipe cleaners (two each of three colors). Around each 15-cm pipe cleaner, students then wrap a 3-cm pipe cleaner of a different color at the 4-cm, 8-cm, and 12-cm marks (these different colors represent dominant and recessive genes). Students should make a color coded key to differentiate dominant and recessive genes. Finally, ask the students to wind the two 15-cm pipe cleaners together. This finishes a simplified chromosome model. Students may then describe their simplified chromosome model to other students. Challenge students to guess how a cell might duplicate this chromosome when the cell is ready to divide to form two new cells.
- Discuss how dominant and recessive genes are passed from parents to their offspring. Then give each student team two brown

paper bags. Have them put five brown and five white seeds in each bag and mark one bag Parent A and the other bag Parent B. Tell students the brown seed represents the gene that controls brown eye color and is dominant; the white seed represents the gene that controls blue eye color and is recessive. Ask students to select one seed from each bag (without looking), predict the eye color inherited from these two parents, and return the seeds to their original bag. This random selection process could be repeated several times, with students predicting in advance what they think the outcome might be.^{1,2}

¹Mendel

²Laws of Inheritance

3. FOSSILS ARE FORMED WHEN ORGANISMS ARE BURIED IN SEDIMENTARY ROCK. FOSSIL REMAINS INDICATE THAT MANY SPECIES HAVE BECOME EXTINCT AND NEW SPECIES HAVE COME INTO BEING OVER GEOLOGIC TIME.

- Discuss the many changes scientific evidence suggests have occurred during geologic time.² Tell students they can reduce the history of the earth and its probable evolutionary events to a 100-m (about a 328-foot) walk. Stretch a 100-m (328-foot) rope along the playground and use flags and posters along it to mark the appearance of plants, dinosaurs, humans, etc. Tell students, "Begin your walk! You are at the time when the earth had no living creatures. Walk 25 m (82 feet) to reach the first life—single-celled organisms. At 40 m (131 feet)—first vertebrates (oceanic); 51 m (167 feet)—first land plants; 62 m (203 feet)—first land vertebrates; 70 m (230 feet)—dinosaurs appear; 88 m (289 feet)—dinosaurs become extinct, birds and mammals appear; 95 m (312 feet)—Grand Canyon is formed; 99 m (325 feet)—first human creatures appear; 99.85 m (327 feet, 6 inches)—Stone Age people appear; 99.9 m (327 feet, 8 inches)—civilized people make the scene; 99.98 m (327 feet, 11 inches)—Columbus discovers America." Finish by asking students: "Scientific evidence sug-

gests humans have been on the earth a short time in comparison to other life. How have we changed the earth? For the better and for the worse?" Guide students to evaluate the available evidence for this theory.

²Geologic Time

- Discuss the formation of fossils in sedimentary rock; then ask students to "build" fossil layers in a paper cup. Have them select four or more pictures, drawings of an organism that shows development from simple to complex forms (e.g., cat, horse, fish), or small items (bone, fern leaf, etc.). Using plastic wrap to separate layers of soil, have them layer their pictures in the cup from most complex to simplest in the following steps: wrap, picture, soil (about 2 cm), wrap, picture, soil, etc.; then have them pack the soil down, tap the sides of the cup, and invert the cup on a paper towel before lifting the cup off the compact mound of "layers." Then, by lifting each layer of wrap an "older fossil" is exposed. Have students list the items found in geological sequence from oldest to most recent. Scientific evidence suggests that the location of specific fossils in certain sedimentary rock layers can be interpreted to help explain the evolutionary development of new organisms.

B. PLANTS

1. ONE IMPORTANT WAY THAT MOST PLANT CELLS DIFFER FROM ANIMAL CELLS IS THAT THEY HAVE A THICKER, STRONGER OUTER COATING CALLED A CELL WALL.

- Discuss plant cell structures; then ask students to observe onion skin cells, elodea leaves, and iceplant epidermis cells under a microscope or with a microprojector. Then ask them to use their observations to compare the differences in the cell walls. These comparisons will help the students draw conclusions about why plants need a rigid cell wall and humans or animals do not.

MODEL PLANT CELL

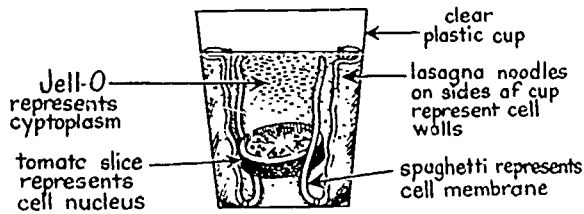

- A model "plant" cell with firm "walls" will reinforce student understanding of the role of the cell wall in plant support. Students can make their own cells out of Jell-O and other common items representing various parts of a cell. Have them use clear plastic cups as "forms"; lasagna noodles for cell walls; spaghetti for membranes; Jell-O for cytoplasm; a tomato slice for the nucleus; etc. Refrigerate the "cells" for several hours. Allow students to "eat" the various parts of their cell later in the day. Ask them which materials in their "model" actually contained microscopic cells similar to the giant one they just consumed.

2. PLANTS HAVE DIFFERENT STRUCTURES (ROOTS, STEM, LEAVES), WHICH ENABLE THEM TO SURVIVE AND ADAPT TO THEIR ENVIRONMENT.

- Ask students "What are some ways plants have adapted to survive in their environment?" Use a cactus and a common (local) flowering plant as discussion examples. "How does the cactus survive in a hot dry desert?" Examine the "leaves" for color, texture, size, shape, etc. "Would a geranium be able to live in 110° F (43° C) heat and with little water? Why or why not?" Challenge students to use their knowledge of basic plant structures to infer and predict after carefully observing these two contrasting plants. Record student comments on butcher paper. Later, hold a plant debate: have students create arguments for and against the survival of a lettuce plant growing "wild" (without care) in the desert.
- Discuss the functions of plant structures; then challenge students to invent a plant that can survive in a particular environment. Assign a different environment to each team (e.g., desert, snow, underwater). Provide

materials such as wood, paper, glue, and rubber bands so models of the "invented" plants can be built. Remind students to consider the conditions in their environment to be sure their "plant" can survive here. When all the models are completed, ask each team to explain the appearance and function(s) of the various parts of their "plant."

3. THE PROCESS OF PHOTOSYNTHESIS ENABLES PLANTS TO ABSORB SUNLIGHT AND PRODUCE THEIR OWN FOOD; THIS PROCESS RETURNS OXYGEN TO THE AIR AND WATER WHILE USING UP THE CARBON DIOXIDE "WASTE PRODUCTS" OF PLANTS AND ANIMALS.

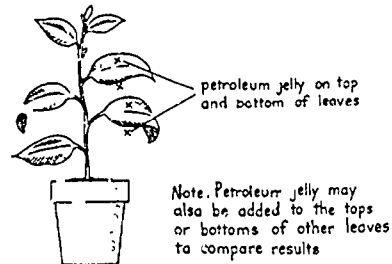

- List and discuss the raw materials necessary for photosynthesis; then ask students to demonstrate that blocking the pores of a plant prevents photosynthesis from taking place.² Have them spread petroleum jelly on the top and bottom of several leaves on a live plant. Have students predict what will happen. Observe/record for two weeks; the leaves will lose their green color. The jelly prevents the movement of gases through the pores; thus, no carbon dioxide, a necessary raw material for photosynthesis, can get into the leaves.

²Photosynthesis

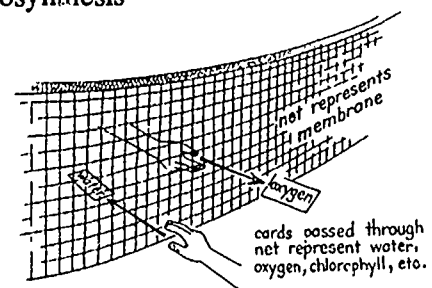

- Review the raw materials and products of photosynthesis; then have students act out the process of photosynthesis in a large leaf cell. Hang a volleyball net across one corner of the room to represent the cell wall and cell membrane of a plant cell. Have a group of seven to ten students prepare and carry cards that identify them as "water," "oxygen," "chlorophyll," etc. Students pass the cards through the net to show permeable membrane action as "sun," "oxygen," or "water" enter the corner "leaf cell," go to "chlorophyll," and leave as "sugar" or "carbon dioxide."⁴ During the process of photosynthesis materials move into and products move out of the cell.

⁴English-Language Arts, Drama

4. FLOWERS ARE A PLANT'S REPRODUCTIVE ORGANS, PRODUCING MALE AND FEMALE SEX CELLS THAT DEVELOP INTO SEEDS AND ARE DISPERSED IN A VARIETY OF WAYS. SOME FLOWERING PLANTS CAN REPRODUCE FROM VEGETATIVE PARTS SUCH AS ROOTS AND STEMS.

- Show students examples of several different kinds of seeds. Then have students gather seeds by wearing socks over their shoes and running through the playground, field, etc. Students may make a map of what type seeds exist in different areas; also, ask them to classify seeds by a variety of properties.* Ask how different animals' fur may be similar to the socks. Thus, students can compare how certain seed structures are adapted for dispersal of those seeds by different animals.

SAFETY: Caution students to watch out for broken glass, snakes in tall grass, etc.

*Book to identify seeds: *Wildflowers*, by Barton

- Describe the process of vegetative reproduction to the class. Then ask students to prove that new plants may be started from old plants. For example, have them begin rooting old carrot tops, potato eyes, cut-

tings from ground covers, violets, avocado seeds, sweet potatoes, pineapple tops, etc. Plant tops can be placed in a shallow pan with water; typically, new roots form where the cut surface is kept covered by water. Have them compare growth rates and structures.

5. HUMANS USE PLANTS TO CREATE MACHINES, CLOTHING, BUILDING MATERIALS, FUEL, FOOD, ETC.

- List several items in the classroom, such as paper and wooden tables, that are made from plants. Then ask students to bring items from home and assemble an in-room "museum" with labels to show plant uses for medicine, clothing, wood, fuel, food, etc. Invite another class to visit this "museum" and learn more about the display by asking your students to explain these helpful uses for plants.
- During a social studies unit on California Native Americans, give some examples of how they used plants. Then ask students to find in reference materials many examples of the unique uses of plants by our Native Americans. Students may construct models of housing structures and boats from reeds, bark, brush, and wooden planks; make a chart, diorama, or model to show the stages of acorn flour preparation; or gather plants and label each to show how they were used as medicines.⁴ Ask students to list the scientific properties or structures of the plant they researched and explain how they think those properties/structures helped make the plant useful to the Native Americans in California.

⁴Social Studies, English-Language Arts, Art

C. PROTISTS

1. FUNGI SUCH AS MOLDS, MUSHROOMS, OR YEAST ARE SIMPLE PLANT-LIKE ORGANISMS THAT LIVE OFF PLANTS OR ANIMALS, WASTE PRODUCTS, OR ROTTING MATERIAL. ALGAE ARE SIMPLE PLANT-LIKE ORGANISMS THAT LIVE IN WATER.

- During early November, begin a discussion of fungi such as molds. Keep a carved Halloween pumpkin until it has plenty of mold. Use hand lenses or a microscope to observe the mold. Bury the pumpkin on the school grounds and have students predict what will happen to it. Dig up the pumpkin in the spring, check predictions, and prepare and record conclusions about what happened. The pumpkin remains should be nearly or completely rotted.

SAFETY: Wash hands; be careful not to breathe mold spores.

- Conclude a discussion of algae by growing algae from a nearby pond or stagnant water in jars or small aquariums placed in different lighting conditions. Have students check the rate of growth and use an eyedropper, slides, and a microscope for a closer look at samples. Have them illustrate their observations. Some kinds will have one cell; others may be strands or filaments of several cells.⁴

⁴Art

2. PROTISTS MAY BE EITHER BENEFICIAL OR HARMFUL TO HUMAN BEINGS AND THE ENVIRONMENT. CONTROL OF HARMFUL ONES INVOLVES BOTH PUBLIC POLICY AND PERSONAL BEHAVIOR.

- Explain to students how common protists are in the environment. Then have students moisten bread and wipe the floor, door knobs, etc., to gather spores, etc. Place the spores in a ziplock Baggie (double bag) and store in a dark, warm area. Pretreat the contents of half the bags with products designed to control or prevent growth of harmful protists. Students will learn the effectiveness of various control methods.^{1,4}

SAFETY: Do not open bags; the contents may cause allergic reactions in penicillin-sensitive students.

¹Beadle
⁴Health

- Ask students whether they know the difference between the common cold and a strep throat infection. Then, to help them distinguish between bacterial and viral infections, ask the school nurse, a local pharmacist, a doctor, or a public health official to talk to the students about "Bacteria and Virus Problems: Causes and Controls." Afterward, help students make a chart comparing the two.^{1,2,4}

¹Fleming
²Germ Theory
⁴Health

D. ANIMALS

1. ANIMALS CAN BE CLASSIFIED IN SEVERAL WAYS, SUCH AS BY SIMILARITIES IN BODY STRUCTURES (E.G., VERTEBRATES AND INVERTEBRATES).

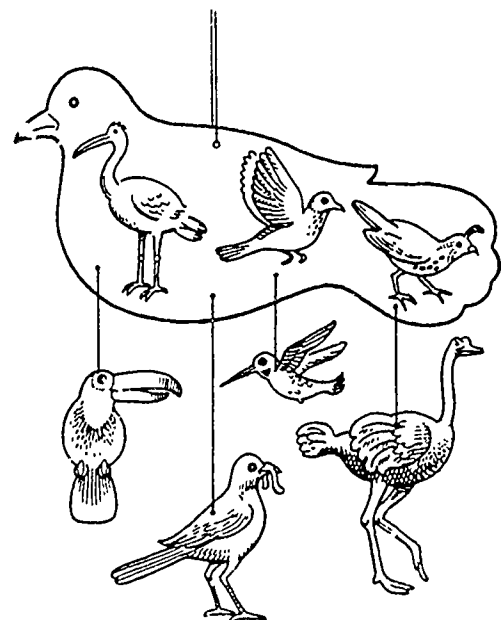

- After introducing the concept of classifying animals, have students create animal family mobiles. Provide a large selection of old magazines and have them cut out all of the animal pictures. Make a large outlined shape of an animal to represent each of the

classes of animals (birds, fish, mammals, etc.). From each large outlined shape hang smaller outlined shapes of representative animals from that class. Have students glue on each outlined shape their animal pictures that match with each class (all bird pictures on the bird outlines, all fish pictures on the fish outlines, etc.). Students should be able to visualize relationships within and between classes by studying their mobiles.^{1,4}

¹Linnaeus

⁴Art

- Have students make a list of animals on the chalkboard. Assign one animal to each student and have them write the name on a 3 x 5 card. For each round of the game, the teacher will assign a classification scheme—body coverings, movement, habitat, skeleton/no skeleton, etc. The teacher gives a classification characteristic (e.g., animals that lay eggs). All students with animals possessing this characteristic will stand, give their animal's name, and sit down. A new characteristic for the classification scheme is given, and the game proceeds.¹

¹Cuvier

2. ANIMALS HAVE ADAPTATIONS THAT ENABLE THEM TO SURVIVE IN THEIR SPECIFIC ENVIRONMENTS.

- Show several examples of adaptations that help animals hide from their enemies. Then have students play a "Protective Coloration" game outdoors. Select an area on the playground and divide the class into two teams. Give Team 1 equal numbers of a variety of colored paint chip strips from a paint store or squares of colored construction paper. Pieces of colored string or yarn may be used also. After Team 1 hides the chips, Team 2 finds as many as it can in 15 minutes. Compare and graph the number of each color Team 2 could find. Students should now realize the value of a color that blends with the environment.

- Discuss several ways various animals are adapted to find food and shelter in their environments. Then challenge students to "Invent an Animal" with simple materials that will blend into a particular local habitat found on the school grounds. Materials should include vegetable bodies (potatoes, white marshmallows) and sticks, toothpicks, tape, rubber bands, string, yarn, clay, cotton, pipe cleaners, paper, or whatever for adaptations. Use tempera paints (thick) to camouflage the animals. Select two sites (with a visual barrier between them) and divide the class into two teams. Each team hides its animals and then switches sites and tries to find the other team's animals. Ask students whether their invented animal would have survived long enough to obtain food; if not, why not?

3. ANIMALS OBTAIN THEIR ENERGY FROM FOOD IN THE FORM OF PLANTS, OTHER ANIMALS, AND PROTISTS.

- Discuss how animals obtain food energy from plants. Have students observe this directly by giving students one snail each and having them feed it small pieces of lettuce (crickets from a pet store, in a clear plastic cup, or moist bread may be used). Provide hand lenses for "close-up" observations of snail feeding and movement behaviors. Help students understand that food energy is changed into energy of motion and other life activities.
- Define the terms *herbivore*, *carnivore*, and *omnivore*; help students apply those terms to the correct animals during a discussion of a typical food chain. Then ask the students to make herbivore-carnivore-omnivore mobiles. Make three large outline patterns: rabbit-herbivores; mountain lion-carnivores; bear-omnivores. Have students cut out and classify pictures of animals from magazines, glue them to tagboard, cut them out, and hang them from each representative outline pattern. Ask the students to write a story about how one of the animals obtains its food.⁴

⁴Art, English-Language Arts

4. MOST ANIMALS REPRODUCE SEXUALLY. THOSE THAT CARE FOR THEIR YOUNG USUALLY PRODUCE FEWER YOUNG.

- Ask the class how many puppies or kittens are usually born in one litter. Then get a female and male guppy from a pet shop. Place them in a glass bowl half-filled with water that has been standing overnight and add several sprigs of water plants. After young are produced, remove the male to a separate container. Feed sparingly with fish food as directed on the package. Ask students to record how many young are produced in one month. Then ask them to compare this number with that of animals that care for their young.
- Discuss with the students how many offspring would be needed to ensure species survival in an environment with many predators compared to one with few predators. Have them gather data on how many eggs are laid by different species of fish from reference materials or local resource people. Make bar graphs to compare the differences. Discuss whether these differences are related to their habitat. Ask each student to "adopt a fish" and write a short report about its fascinating facts, especially the life cycle and why each fish lays only a certain number of eggs.⁴

⁴English-Language Arts, Mathematics

5. ANIMALS PROGRESS THROUGH A LIFE CYCLE AND HAVE THE SAME PATTERN OF DEVELOPMENT FROM GENERATION TO GENERATION.

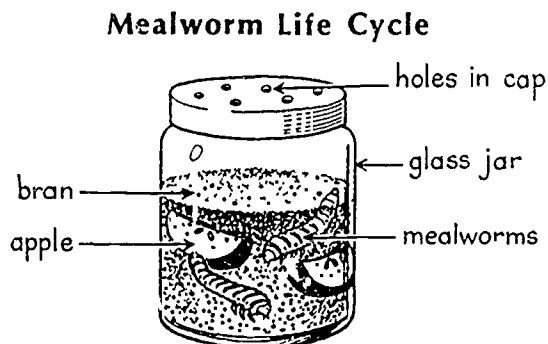

- Show a film depicting the life cycles of several common animals. Then, in the classroom, establish a mealworm colony using large containers of bran for food with potato or apple slices for moisture. Ask students to observe the mealworms in various stages of growth during a one-month period. Observe several generations as they develop and compare the stages of growth. Finally, compare the mealworm's life cycle with some of those shown in the film.

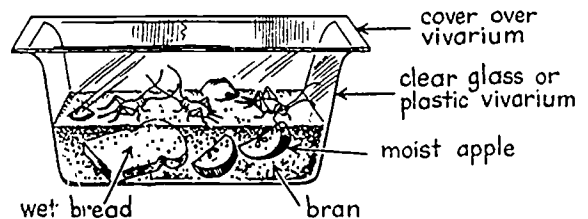

- Describe the difference between incomplete and complete metamorphosis. Have students observe incomplete metamorphosis by observing crickets purchased from a pet store. House them in a small container with bran flakes, wet bread, moist apple, etc., and study all stages of development. Then have students record the incomplete metamorphosis and compare it to complete metamorphosis with mealworms as in the above activity. Students will learn that the life cycles of different organisms show different patterns and take different lengths of time.

6. WE CAN RAISE AND KEEP SOME KINDS OF ANIMALS FOR USE AND ENJOYMENT WITH PROPER CARE; BEHAVIORS AFFECTING THE WELFARE OF PETS, DOMESTIC ANIMALS, AND WILDLIFE INVOLVE PERSONAL RESPONSIBILITY AND SOCIAL POLICY.

- Ask students to describe the home their family provides for their favorite pet. Have them list ways their pet's basic needs are met. Then have students make posters of the "ideal home" for a wild animal and a pet. What are the differences? Why? Then have students make a miniature "real" home for an animal of their choice. How could they make the perfect home for a lizard? For a worm? For a frog? For a pet rabbit? For a horse? etc. Help the students

be sure they have planned for the proper care for their animal.

- Discuss the role of friends and neighbors (the community) in being sure animals are treated with respect (humanely). Plan a field trip to or invite a speaker from the local humane society. Ask the speaker to discuss people's responsibility for pets and wildlife. How are pets different from wildlife? Why is it so critical to care for a pet's needs and yet not feed or touch wild animals? Stress that because people's activities have changed the natural environment in so many ways, people must take responsibility for their pets and the wild animals that remain. Have students write a letter to their local humane society requesting information on the humane care of animals.⁴

⁴Social Studies, English-Language Arts

- Discuss the circulatory system; then set up a room-size model of it. Students become the red blood cells and begin their journey at the heart. From there, they move through arteries to the next station, the lungs, and pick up cards labeled "oxygen." After returning to the heart, they circulate to other body parts and "deliver" the oxygen before the red blood cells return to the heart through a vein. Students should now be able to draw and label a diagram showing the circulatory path in the human body.^{1,2}

¹Harvey

²Circulation of Blood

2. HUMAN BEINGS GROW AND DEVELOP IN SIMILAR WAYS, BUT AT VARIOUS RATES. ADOLESCENCE IS A PERIOD OF RAPID, UNEVEN GROWTH AND DEVELOPMENT WHEN SEXUAL MATURATION OCCURS.

E. HUMAN BEINGS

1. THE ORGANS OF THE HUMAN BODY FORM SYSTEMS THAT CARRY ON ESSENTIAL BODY FUNCTIONS.

- Help students learn about a particular organ in the human body by asking them to "Interview an Organ." Ask them to select a particular organ or system of the body and list its characteristics. Then ask their classmates to play "guess who?"—name that organ. Next, have them cut out the shape of an organ, write a description of its structure and function on it, and place it onto the outline of a large paper body for display. Students should be able to identify and describe a variety of organs and systems.

- Ask students to remember how they looked and behaved when they were three to five years younger. Then ask them to bring in pictures of themselves at various ages and place them in chronological order. Have a "baby face" contest to match baby pictures to the students in the room. Students may make a pictorial poster of family, parents, grandparents, etc. Discuss how the students have changed; then have them predict in what ways they expect to change as they become adults by having them draw self-portraits at middle and old age. Have them evaluate and discuss the physical changes that have occurred or will occur.⁴

⁴Art, Health

- Discuss the concept of "average" as it applies to body weight, height, etc. Then ask students to begin a search for the most "average" student. Each student is measured for a set of common features: arm span, head size, etc. All measurements are charted and averaged. Students compare their measurements to those of the "average child." A description is written that illustrates this "average" student.⁴ (Adapted from Project AIMS.)

⁴Mathematics

MODEL OF CIRCULATORY SYSTEM

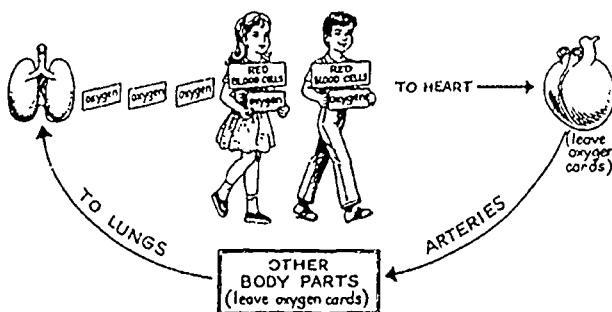

3. HUMAN REPRODUCTION OCCURS WHEN AN EGG AND A SPERM UNITE.

- During the discussion of human reproduction, have an anonymous question and answer box in class so students can ask questions. Ask the school nurse to respond to these questions. This technique gives students answers to their questions in a non-threatening manner.⁴

⁴Health

- To introduce the social aspects of boy-girl relationships, invite the school counselor or nurse to come in to talk about adolescence and sexuality. Ask the presenter to answer questions and relate her or his experiences and awkwardness. Caring, sensitive family relationships can be fostered through this discussion.⁴

⁴Health

F. ECOSYSTEMS

1. A POPULATION CONSISTS OF ONE SPECIES THAT LIVES IN A LIMITED AREA. POPULATIONS CONTINUE TO BECOME ENDANGERED, AND SPECIES MAY BECOME EXTINCT.

- Discuss what happens for a species to become "endangered." Ask students to select an endangered species and research the causes and plans for future protection for that species. Impress upon the students that wildlife serves as an integral part of the food chain and is a barometer for the continuation of human life. Invite guest speakers from concerned community organizations; have students make posters illustrating the need for protection of endangered animals; or have students write letters to concerned organizations for information. Then form a "mock court" to try various alleged offenders against selected endangered species.⁴

⁴Social Studies, English-Language Arts

- Help students identify essential habitat components, limiting factors, and the fact that some fluctuations in wildlife populations are natural. Have students role-play these concepts as deer. Students count off in fours—ones become deer; twos, threes, and fours become food, shelter, and water in the "environment." At a given signal, the deer walk through the "environment" and select one item: food, water, or shelter. Students that have been selected by the "deer" group become part of the deer population. Any deer that cannot find what it needs in the environment dies and becomes part of the "environment" group. Repeat the procedure several times; then graph and interpret the changes in the deer population over several generations (or turns). (Adapted from Project Wild; refer to the project for detailed directions and extensions.)⁴

⁴Mathematics

2. AN ECOSYSTEM CONSISTS OF A COMMUNITY OF LIVING THINGS INTERACTING WITH EACH OTHER AND THE ENVIRONMENT. MOST ECOSYSTEMS DERIVE THEIR ENERGY DIRECTLY OR INDIRECTLY FROM THE SUN.

- Ask students, "How are the people living in a city (a community) interdependent?" Then have students list all the people that help keep the city (or community) and the people in it going. How do they need each other? Write the list on the board and then draw lines to connect the people who depend on one another, e.g., farmer, baker, plumber, automobile mechanic. Ask students to compare this human "web of life" with that found in a forest. (Adapted from "Caught in the Web of Life" from *The Growing Classroom*, p. 194.)
- Discuss ways the original "stored" energy from the sun is lost as that energy is transferred up the food pyramid. Place 20 M&M's or jelly beans in each of 20 sandwich bags and have at least seven extra "empty" sandwich bags. Then select

20 students as "producers," give each a filled bag, and instruct each "plant" to eat five M&M's (energy units), leaving 15 units of energy stored. Next, select four students as first-order consumers ("herbivores"); give each an empty bag and instruct him or her to collect 12 energy units (M&M's) from five plants and put them in his or her bag; each "herbivore" now eats 30 energy units, leaving 30 in his or her bag representing "stored" bones, flesh, fat, and organs. Next, select two students as second-order consumers ("omnivores"); give each a bag and instructions to catch two herbivores, taking 30 energy units from each one; each "omnivore" now eats 30 energy units, leaving 30 "stored" in his or her bag. Finally, select one student as the third-order consumer ("predator," "carnivore"), who collects the remaining 60 energy units from the second-order consumers and eats 30 energy units, leaving 30 for growth, good health, and reproduction. Challenge students to describe each level where "lost" energy goes; help them realize its use in the life activities of breathing, moving, etc. (Adapted from: *Green Box*, "Introductory Think Activities," pages 27-28.)

3. FOOD CHAINS AND FOOD WEBS REPRESENT THE FEEDING PATTERNS OF THE MEMBERS OF AN ECOSYSTEM.

- Discuss predator-prey relationships; then have students play "Predator Play—A Game of Tag" on the playground. Select a typical food chain with at least three to four different animals; for example, grasshoppers, frogs, snakes, and hawks. Identify a different color crepe paper arm band to represent each kind of animal and distribute one band to each student so there are many grasshoppers, fewer frogs, a few snakes, and one to three hawks. Scattered popcorn represents the food source (plants). Give each animal a plastic Baggie "stomach" with a horizontal line on it to identify the food consumption necessary for its survival. All predators remain off the field until signaled; grasshoppers gather food

(popcorn). When the teacher signals the predators to enter the field, they tag only their own prey (frogs eat grasshoppers, snakes eat frogs, and hawks eat snakes) and capture its stomach (Baggie), adding its contents to their stomach (Baggie). Predators who escape tagging and surpass the food level on their stomach (Baggie) survive and win the game. Change the numbers in each animal group and switch animal identities for future rounds.

- After discussing food chains and food webs, have students play the "Food Web" game. Ask students to brainstorm various food chain groupings; record ideas on the chalkboard. Then have students label a separate 4 x 6 card for each animal/plant. Make one card labeled Sun—source of energy. Select a student to represent the sun and place the student in the center of the other students arranged standing in a circle and each holding a different plant or animal card. The "sun" is given a ball of string and holds the loose end. A student holding some type of plant card will take the string ball and pull it back to his or her place in the circle. Then a student who eats this plant will take the ball from the "plant" while the "plant" student still holds the string. Students will continue to come forth and take the ball of string from "organism" to "organism" until several food chains are made and inter-webbed. Finally, the "sun" calls out the extinction of one organism. That organism drops the string, causing "slacking" in the string which represents death to all organisms that feel slack. This causes a chain-like reaction. Students should now be able to write a story telling about several food chains that form a food web in an environment of their choice or telling what happens when one organism is removed from the food chain.^{1,4}

¹Conservation

⁴English-Language Arts

EARTH SCIENCE (4-6)

A. ASTRONOMY

1. THE EARTH'S ROTATION, REVOLUTION, AND AXIS TILT CAUSE SPECIFIC CLIMATIC CHANGES IN THE NORTHERN AND SOUTHERN HEMISPHERES.

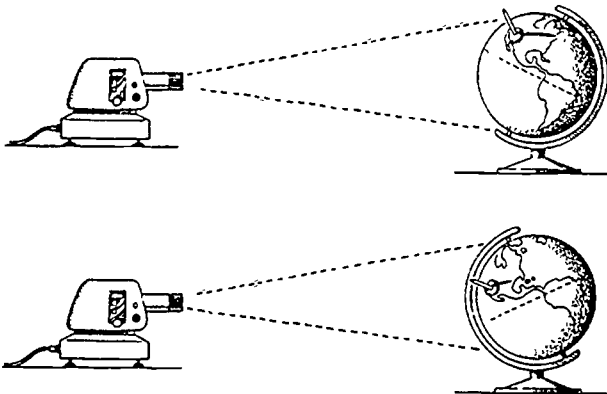

- Show students how the tilt of the earth's axis causes different effects in different seasons. Use a bit of clay to fasten a roofing nail upside down on a globe at the place where you live. Adjust a slide projector so its beam hits vertically at the equator. Then position the globe so its 23 1/2 degree tilted axis points away from the slide projector and have students measure the shadow length (this is winter). Next, position the globe so its axis points toward the projector; again, have students measure the shadow length (this is summer). Help students understand how shadows are longer in the winter (the sun is lower in the sky) and shorter in the summer (the sun is higher in the sky).

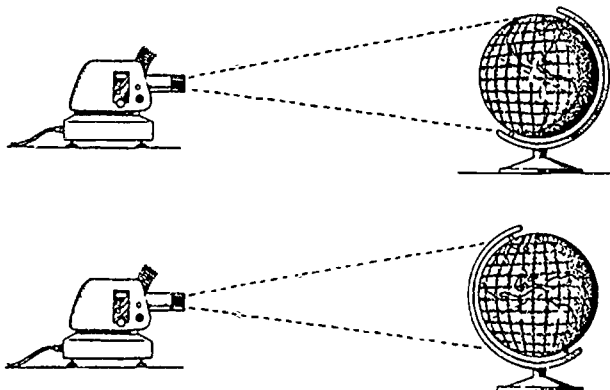

- Ask students how concentrated the sunshine is in summer compared to winter. Help them find out by cutting out a 2 in. x 2 in. (5.1 x 5.1 cm) piece from a discarded window screen and mounting it in a slide projector. Shine the resulting grid onto a globe at the place where you live (for the summer position the globe's axis should point toward the projector; for winter, away from the projector). Ask students to compare the number of squares that appear in both cases. Also, ask them when the squares are brighter. They will observe more and brighter squares during the summer position, showing that more light is concentrated on a smaller area then.

2. THE MOON'S ROTATION, REVOLUTION, AND REFLECTION OF THE SUN'S LIGHT CAUSE PREDICTABLE CHANGES IN THE MOON'S PHASES AS WELL AS ECLIPSES.

- Help students understand the moon phases we all observe by preparing a take-home monthly calendar with large squares for students to draw the different phases of the moon as they observe them each night. Ask students to make these observations and drawings at home and bring the completed calendar back to school at the end of the month. They may check the newspapers for any missed observations (cloudy nights). A large class calendar may be kept at school and filled in daily. Discuss how the moon's revolution around the earth causes us to see different amounts of its lighted surface at different times during the month.

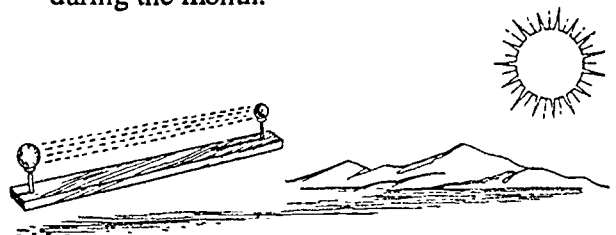

- Discuss how an eclipse is caused; then drive in a long nail perpendicularly near each end of a stick 11' cm long. On one

nail glue a Ping Pong ball (earth) and on the other end put a clay ball (moon) with a diameter of 9.5 mm. Position the stick in the sunlight so that the shadow of the moon falls on the earth, or vice versa. Ask students to observe the umbra and penumbra. Help them understand the difference between a partial and a full eclipse in terms of the viewer on the earth being located in either the umbra (total eclipse) or penumbra (partial eclipse) portions of the shadow.

3. THE SUN IS THE CENTER OF THE SOLAR SYSTEM AND IS A MASSIVE SPHERE OF HYDROGEN AND HELIUM THAT RELEASES ENERGY THROUGHOUT THE SOLAR SYSTEM.

- Ask students, "How does distance from the sun affect how much heat a planet receives?" Demonstrate by setting up an unshielded glowing light bulb; ask a student to hold one hand 1 m away from it. (SAFETY: Have the student shield his or her eyes with the other hand.) Then have the student gradually move his or her hand closer to the bulb. (SAFETY: Do not touch bulb.) Ask him or her to tell the class when the heat is first felt and how the heat feels when the "planet" is even closer to the "sun." Other students in the class may wish to experience how a "planet" gets "warmer" as it gets closer to the "sun," just as it happens to the inner planets in our solar system.
- Demonstrate the construction of a solar cooker. Then have students build their own, selecting a type of material they predict will concentrate the most heat to cook an apple slice. A cone may be made from a variety of materials, such as tin foil, black paper, or white paper, and taped to a Styrofoam cup lined with the same material. A thin slice of apple may be threaded on a skewer or toothpick as it is threaded through the cup. A thermometer may be placed in the cup, and observations and temperature readings may be taken to compare each type of material used. Help students understand that the cooking heat came from the sun's concentrated energy.²

²Sun Power/Solar Energy

4. THE SOLAR SYSTEM CONTAINS SPHERES AND CHUNKS OF MATTER THAT REVOLVE AROUND THE SUN. THE LARGEST BODIES ARE PLANETS, MOST OF WHICH HAVE MOONS, AND OTHERS ARE ASTEROIDS, METEORIDS, COMETS, AND A MULTITUDE OF SMALLER PARTICLES.

- Suggest to students that it is possible to make a model of the relative distances of the planets from the sun. Form groups of three or four students and assign one planet to each group. Have each group prepare a length of string equal to the distance of its planet from the sun using the scale 2.5 cm = 1 609 000 km (for example, earth at 149 637 000 km = 232.5 cm). Have an extra group cut a large sun out of construction paper and place it in the center of the playground. Then have each planet group attach its string to the sun and stretch the string to its full length. When all planets are spaced around the sun, have them move in the same direction in their orbital paths, simulating the revolution of planets in their orbital paths. (REMINDER: This model misses the elliptical nature of the planets' actual orbits.) Students may wish to expand this activity by making a scale size paper "sun" and "planets" to put at the outer end of their strings and move in their orbits at the correct orbital "speeds."¹

¹Copernicus (See page 2 for an explanation of entries like this one.)

- Discuss the discovery of planets, comets, and asteroids; then have students make a "Time Line of Space Discoveries." Have them research the dates and discoverers of the various objects found in our solar system. They may start with newsclips of recent discoveries and work backwards to develop the time line; then have them put it up in the classroom, or hallway if the time line is too large. This historical perspective will give insight into the process by which knowledge in astronomy, applications of new technology, and understanding of our own planet earth have developed.¹

¹Brahe, Maria Mitchell

- As students learn about the surface features of known planets, moons, and asteroids, demonstrate how scientists believe craters may have been formed. Fill a box or large baking pan about 3 or 4 cm deep with flour, talcum powder, or baking soda (a thin layer of talcum powder over flour would show effects of layers). Then drop marbles, golf balls, and/or small rocks into the container from the same height. It may help to tie a string around the small rock and pull it back out after impact, thus simulating a "bouncing" crater formation or an object that completely disappeared beneath the surface. Ask students to compare the features of the "craters." The crater walls and splash effects will vary with the size of the object and speed/angle of impact.

5. ASTRONOMERS IDENTIFY STAR GROUPINGS AS CONSTELLATIONS AND GALAXIES. SPECIFIC STAR CHARACTERISTICS CAN BE DETERMINED FROM STARLIGHT.

- Students will probably already have heard about groupings of stars called constellations and given names such as Big Dipper and Orion by ancient astronomers. Have them make models of various constellations by attaching miniature marshmallows together with toothpicks and gluing the patterns onto paper (different colored marshmallows could be used to represent different magnitude stars; also, paper cutouts could be used instead). Students may wish to superimpose drawings of the constellations that were created by various ancient cultures. Also, the class may concentrate on the polar constellations and mount them on the classroom ceiling around the North Star. Help the students realize how real patterns in nature were given mythical explanations by ancient cultures and that these names are still used today on star maps.¹

¹Herschel

- Help students visualize the "expanding universe" model used by many astronomers by having them randomly place three dots (X, Y, Z) on a deflated large round

balloon, using a felt-tip pen. Then have them put a small amount of air into the balloon and use a string and a ruler to measure and record the distance between the dots. Next, have them add more air to the balloon and again measure/record the distance between the three dots. Have them repeat the procedure one more time. Ask them, "What has happened to these three 'galaxies' (dots) in your 'universe'?" They should be able to explain how all three "galaxies" constantly get farther apart from one another and from the center of their "universe."

B. GEOLOGY AND NATURAL RESOURCES

1. ROCKS ARE CLASSIFIED ACCORDING TO THE PROCESS BY WHICH THEY ARE FORMED (IGNEOUS, SEDIMENTARY, AND METAMORPHIC).



- Discuss the process of forming sedimentary rocks; then have students model the process by filling a glass or plastic jar two-thirds full with soil and adding water to near the top before replacing the cap. Next, they shake the jar until the soil has thoroughly mixed with the water. Finally, have them let the mixture settle. After a period of time, perhaps even the next day, they can observe the settling of the sediments into distinct layers. Help them compare the particle sizes in the different layers with those of various types of sedimentary rocks: conglomerate, sandstone, shale, etc.
- Once students learn the meaning of the changes involved when metamorphic rock is formed, have them model the process by softening (by kneading or warming) a golf

ball size or larger lump of modeling clay. Then have them insert small steel washers into the clay ball from all sides so that none is parallel to another. Next, have them put the clay/washers lump between sheets of wax paper on the floor and lay a book or small board on top. Finally, have them stand on the book to flatten the clay lump and then remove it to look at the alignment of the washers. Help students compare their "model" with a natural specimen of a metamorphic rock, such as schist, that has flattened, aligned crystals. Ask whether they think heating their lump, such as happens deep in the earth, would have helped the lump "change" (metamorphose) more.¹

¹Hutton

2. MINERALS HAVE SPECIFIC PROPERTIES (COLOR, HARDNESS, LUSTER, CRYSTAL SHAPE) BY WHICH THEY CAN BE CLASSIFIED AND WHICH MAKE SOME OF THEM USEFUL ECONOMICALLY.

- Discuss the properties of minerals; then have students set up their own "hardness" chart by using rocks they find and simply seeing whether one will scratch another. Then have them compare their chart with the Mohs' Scale of Hardness found in a reference book or a commercial test kit. Be sure they understand that a rock that scratches another is the harder of the two, and that comparisons based on this fact have led to the development of Mohs' Scale of Hardness.²

²Mohs' Scale of Hardness

- As students observe a variety of rock specimens, they will note many different kinds of crystals. Help them understand how crystals form by providing them with a variety of different kinds of crystal recipes. In each case, each group should make a "super-saturated" solution and allow it to evaporate, uncovered, in a quiet environment. Students may experiment by varying the following: amount of salt, type of container, temperature, objects crystals

grow on, etc. Help students compare the effects of these variables with changing conditions in nature that have led to crystals of different size, shape, color, etc., in similar rocks (e.g., granite used in tombstones).²

²Agricola

3. WEATHERING AND EROSION ACT ON ROCKS AND MINERALS TO CHANGE LANDFORMS, CREATE SOIL, AND AFFECT HUMAN ACTIVITIES.

- Show students a picture of a large mountain boulder or rock slope that has layers "peeling" off much like an onion. Demonstrate how this might have happened by soaking several pieces of porous rock (sandstone, limestone, pumice) in water for an hour. Place the pieces in a plastic bag and set the bag in a freezer overnight. Allow students to examine the rocks the next day and have them compare the changes they observe and the picture of the "peeling" boulder they saw earlier. Help them understand how freezing water expands and can break seemingly very "hard" rocks. This process can damage buildings, roads, statues, etc.
- Discuss the effects of "acid rain" on the beautiful old buildings and statues in Venice, Italy, as well as major cities in our country. Students can experiment with this process by filling two jars half full of water and a third jar half full of vinegar. Then have them blow through a straw into one of the jars. Next, place a few limestone-containing rocks into each jar and have students observe/record the results. They will see the limestone rocks begin to react in the presence of an acid (the vinegar and carbon dioxide [carbonic acid] solutions act like acid rainwater) to show signs of chemical weathering.

4. EARTHQUAKES AND VOLCANOES OCCUR ALONG FAULT LINES, RELEASING LARGE AMOUNTS OF ENERGY AND CHANGING LAND FORMS.

- Near the beginning of a class discussion of earthquake and volcano locations and concentrations, have students gather information on the positions of (1) mountain ranges; (2) areas of volcanic activity; and (3) zones of earthquake activity. Then have them plot these features on a world or Western Hemisphere map. Ask them whether they detect any patterns in the data they have plotted; also, whether the phrase "Pacific Rim of Fire" has any basis in fact. Help them see that some force deep in the earth must be causing pressures in certain areas that lead to earthquakes and volcanoes.
- Present the basic concepts of the Plate Tectonics/Continental Drift Theory. Then ask students to theorize why both North and South America are drifting westward. Demonstrate this "drift" by gently and slowly pushing a small rug across the floor (push from its trailing edge). Have students observe how the rug develops folds along its leading edge; ask them how this is similar to the western edge of North and South America. Then show a movie or pictures of scientific drawings that depict how scientists believe currents in the hot interior of the earth cause "plates" or blocks of crust to move across the earth's surface.

- Discuss the earth's resources and how we use our land and water; then ask students: "How much usable land and water *do* we have on this planet?" Help them visualize the answer by demonstrating as follows: Cut an apple into four quarters; set three of them aside. The remaining quarter represents the part of the earth's surface that is not covered by ocean. Now cut this piece in half; set one of these pieces aside. The remaining piece represents the part suitable for human habitation; the other is too dry, too wet, too cold, too mountainous, etc. Now cut the last piece into four. One of these is the part of the earth that we can grow our food on. Then cut a slice off one of these; this is the 3/100 of 1 percent of the earth's surface that supplies all our potable (drinkable) water. Ask students, "Now that you've seen this, is conservation a good idea? Do most people conserve? Why, or why not?" Help them see how the finiteness of our resources and the expansion of our human population indicate great need for conservation techniques.
- Discuss recycling with the students. Ask them, "What is it? Why do it? Does it save dollars?" Then have a newspaper and aluminum can drive at your school—a one-day collection—and keep a record of how much is collected and what the earnings are. Challenge other classes to see whether they can beat this record. Help the students realize how important conservation is to our future supply of natural resources like trees, metals, and energy.⁴

5. NATURAL RESOURCES NEEDED BY HUMANS ARE IN LIMITED SUPPLY AND MUST BE CONSERVED.

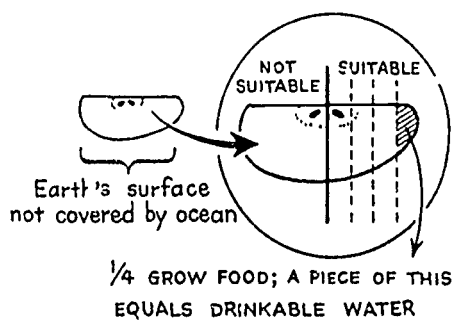
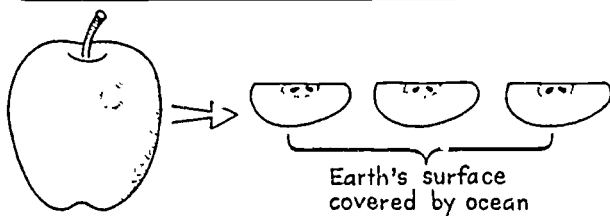

⁴Social Studies

C. METEOROLOGY

1. WEATHER IS AFFECTED BY MANY FACTORS SUCH AS THE SUN-WARMED EARTH, AIR PRESSURE DIFFERENCES, AND MOISTURE IN THE AIR.

- Discuss how land and water surfaces affect the weather; then have students compare the absorption and release of heat by soil and water. Have them fill one can with dry soil and another the same size with water.

Next, have them place both cans outside in sunlight and measure/record the temperature after 2 hours. Finally, have them place both cans in a refrigerator and measure/record the temperature after 10 minutes. Students should readily conclude from their data that soil heats and cools more quickly than water. Thus, land areas warm more rapidly in the day and cool more quickly at night, causing greater weather variations than occur over or near large bodies of water.

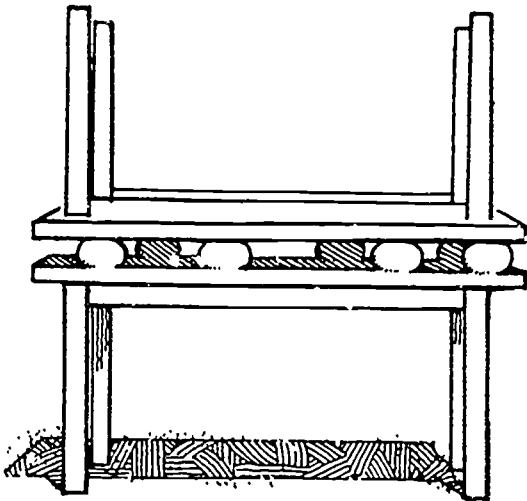

- Tell students, "Air is all around us, and we hear others talk about air pressure, but we never feel this pressure. How can scientists know about air pressure?" Then give each student a sandwich bag and have the students hold them in one hand so they can later blow into them to inflate them. Then group the students around a rectangular table and have them rest their bags around the perimeter of the table surface. Have two student volunteers invert a second, identical table onto the first table with the not-yet-inflated bags as the "sandwich filling." At a given signal, have the students inflate the bags, thus lifting the upside-down table. Ask the students whether they now can say they have seen evidence that air can exert pressure.

2. WIND IS THE RESULT OF MANY FACTORS, INCLUDING ATMOSPHERIC CONDITIONS, SURFACE FEATURES OF THE EARTH, AND THE EARTH'S ROTATION; ALSO, WIND MAY BE USED AS A SOURCE OF ENERGY.

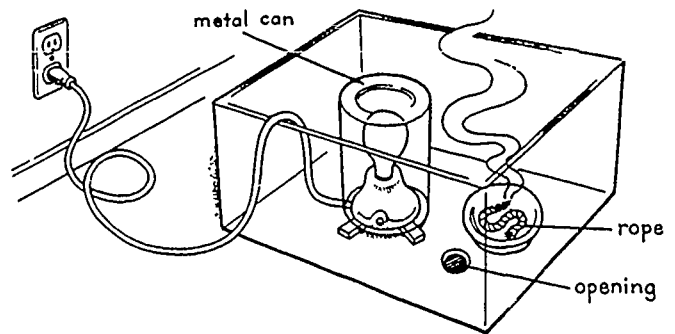

- Discuss convection currents in air as a major cause of winds; then demonstrate the formation of convection currents. Start with a large cardboard box. Put a 100-watt light bulb in a flat bottom ceramic socket on the floor of the box. Cut the ends from a tall metal can large enough to fit over the bulb; arrange a support so air can flow in under the can and up past the bulb. Cover the open end of the box with a sheet of clear plastic film to make a window and cut a small opening at the bottom of the box on the side near the bulb. Place a container with a piece of smoking rope in it next to this small opening. Ask students to observe the path of the smoke in the box when the lamp is lit and compare it to when the lamp is off. The hot bulb warms and expands the air around it, making that air lighter; and the surrounding cooler, heavier air is pulled in by gravity and pushes the lighter air up. Help students see how similar effects in nature can cause strong winds.

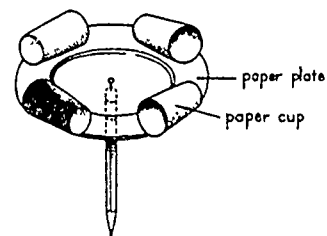

- Students have learned that air can exert pressure and that convection currents can cause winds. Ask them how meteorologists (scientists who study the weather) can measure wind speeds; then have them make a device to do so. Ask them to evenly space four paper cups laid sideways around the perimeter of a paper plate. Have them

attach these cups to the plate, push a straight pin through the center of the paper plate into a pencil eraser, and mark one cup so that the plate's rotations can be easily counted. Choose a windy day to have the students test and calibrate their wind speed measuring device. Invite a local newspaper or TV weatherperson to come to the class to tell about the operation of or, if possible, show an anemometer used to measure wind speeds.

3. MOISTURE IN THE ATMOSPHERE TAKES MANY FORMS AS A RESULT OF THE SUN'S ENERGY.

- Discuss the various forms of moisture that can occur during the water cycle. Have students experiment with these forms by taking two clear jars, filling one halfway with moist soil and the other halfway with water, covering both jar openings with clear plastic wrap and placing both jars in direct sunlight. Ask them to observe what happens and record their findings. Then have them repeat the experiment in indirect sunlight. Discuss any differences they observed; ask them what forms of moisture were present. Help students relate these forms to the states of matter and the kinetic energy of molecules.
- Demonstrate that water vapor condenses on various materials at different rates. Provide similar sized cups made of various materials (paper, waxed paper, Styrofoam, glass, metal), filled with the same amount of ice cubes, and ask students to predict which type of cup will collect water drops first on its outside. Form student teams and have students mark a 1-cm square on the side of each container. At uniform time intervals (perhaps every 30 seconds), an observer should count the number of drops in a square and tell the recorder the total. Then have each team graph the time for drops to appear on each container and the rate of increase after the drops appear. Ask students to develop explanations of the rate of condensation on each container. Also, ask them whether they think the results would

be the same on a day with different humidity.⁴

⁴Mathematics

D. OCEANOGRAPHY

1. MANY OCEAN FLOOR FEATURES ARE COMPARABLE TO LAND SURFACES AND ARE SHAPED BY SIMILAR FORCES.



- Remind students of television specials they may have seen about underwater studies of canyons, coral reefs, the continental shelf, offshore oil drilling, etc., in programs by Cousteau, National Geographic, etc. Ask them how they think underwater contours can be determined from the surface; then have them make a model of an echo sounder. Divide the class into groups of four and give each group a large clear plastic tub or bucket. Have them place one or two metal objects in the bottom and then fill it with water (salt water if available). Have each group select a variety of objects (such as a paper clip, button, rubber band, or penny) to drop into the water and time/record how many seconds it takes for each of them to reach the bottom. Students should drop each object three times, compute an average drop time, and plot the results on a graph. Help them see that this graph represents a profile of the sea floor in the same way that echo sounding readings would.

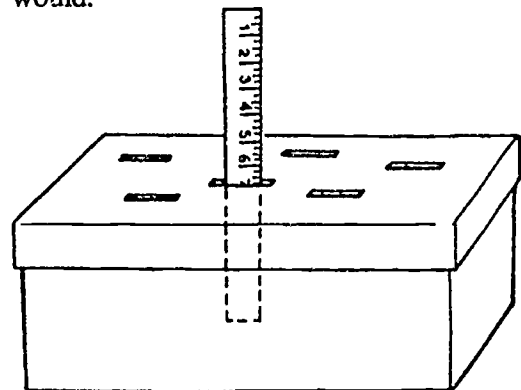

- Discuss underwater land forms; then have students draw a diagram to show the similarities of ocean floor features and land surfaces. Have them include abyssal plain, atoll, continental shelf, guyot or plateau, ridge, seamount, trench, and volcanic island, all labeled. Then have them use their diagram to construct a three-dimensional model in a shoebox with the top of the shoebox being the sea level. Finally, have them cut several slits in the top of the shoebox, put the lid on the box, and trade boxes with a classmate. They may then use a thin plastic ruler to make probing measurements into the box much as an echo sounder would make. Ask them to record the measurements and use them to construct a new diagram of the model sea-bottom topography; a comparison with the original diagram will show how accurate this technique is.

2. THE ENERGY FROM THE SUN INTERACTS WITH BODIES OF WATER (OCEAN ESPECIALLY) TO DRIVE THE WATER CYCLE AND INFLUENCE CLIMATE.

- Discuss the water cycle; then boil water in a tea kettle or pan so steam rises above it. Then hold a metal pie plate with ice cubes in it above the steam. The "steam" water vapor condenses on the bottom of the pie plate, forms drops, and falls as precipitation. Help students see how this demonstration models the heating of the oceans or lakes by the sun, the formation of water vapor, the cooling of vapor high in the atmosphere to form clouds, and finally the formation of drops of rain to complete the cycle.
- Show students how the energy of the sun can be used to help provide fresh drinking water by having them make a solar still. Ask them to place a clear plastic cup in a small plastic Baggie. Next, fill the cup half-way with salt-water solution, tie the Baggie closed at the top, and place it in a sunny spot. Have them wait until water begins to condense inside the Baggie and collect at the bottom of the Baggie. This collected

water should be free of salt because the apparatus utilized the sun's energy to purify the water via the water cycle.

3. TIDES, WAVES, AND CURRENTS ARE CREATED AND AFFECTED BY VARIOUS INFLUENCES.

- During a discussion of the creation of water currents, demonstrate their formation by the mixing of water of different temperatures. First, freeze colored water into cubes. Then place a colored ice cube in an aquarium filled with room temperature water. Ask students to observe and draw pictures of the currents as indicated by the flow of color. Then compare this action to the formation of equatorial and polar currents in the ocean.¹

¹Humboldt

After charting the information, develop a graph.

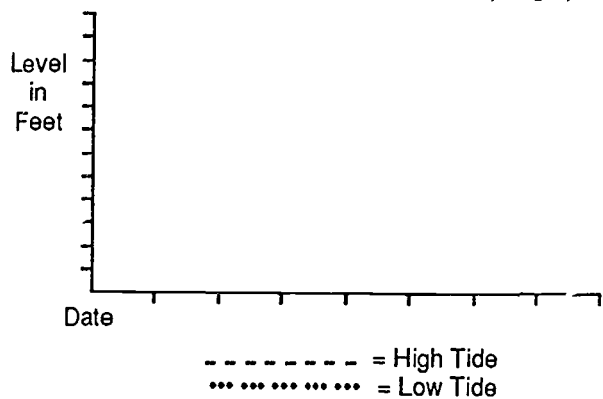

- Collect the tide tables from several daily newspapers. Provide copies of the chart shown here and have students record low and high tide times and levels for several days. Then have them graph each point to see tidal change patterns. Finally, ask students to relate the tidal changes and conditions to moon phases.⁴

PHYSICAL SCIENCE (4-6)

A. MATTER

1. MATTER HAS MASS/WEIGHT AND OCCUPIES SPACE.

- Discuss how the pull (force) of gravity attracts objects (matter) to the earth (a large ball of matter) and this pull between objects gives them "mass" (the same as "weight" for objects at or near the earth's surface). Then have students predict the mass of the edible portion of bananas, oranges, etc. Provide scales or balances so they can weigh the entire fruit, eat the edible parts, and weigh the remaining peelings. Have them subtract the final weight of the peelings from the original weight; they will then know the "mass" (weight) of the edible portion. (Adapted from Project Aims.)^{1,4}

¹Newton

⁴Mathematics (See page 2 for an explanation of entries like these.)

- Conclude a discussion of how matter occupies space by providing an empty jar and filling it with a measured volume of small rocks or large gravel. Ask students to hypothesize whether the jar is completely full. Then add a measured volume of sand, tapping the jar to settle it until full. Again ask students to hypothesize whether the jar is full. Then pour a measured volume of water slowly into the jar until full. Calculate the total volume of matter that has been added to the original volume in the jar. Explain that just as there was a lot of space between the rocks and sand grains, there is also a lot of empty space between atoms and molecules.

2. MATTER IS MADE UP OF MANY DIFFERENT SMALL PARTICLES KNOWN AS ATOMS THAT ARE THE BASIC BUILDING BLOCKS OF ALL MATTER. MATTER CAN BE A PURE SUBSTANCE (AN ELEMENT, MOLECULE, OR A COMPOUND) OR A MIXTURE SUCH AS A SOLUTION.

- Discuss the difference between a mixture and a compound; then prepare a mixture of sand, iron filings, sawdust, salt, and paper clips. Challenge students to think of ways to separate the mixture. Have students develop experiments to test their methods. If necessary, suggest using a sieve (to remove paper clips), a magnet (for iron filings), and water (makes sawdust float and dissolves salt; slop off the sawdust and then pour out the water and let it evaporate to reclaim the salt; the sand is left). Explain to students that these pure substances were only mixed, not chemically combined, and therefore could be easily separated by physical methods.¹

¹Pauling

- Define a pure substance as one that has unique physical and chemical properties; also, it cannot be separated into component parts by physical methods. Then ask students to examine the properties of starch, baking powder, and baking soda by observing through a hand lens. Have them test the reaction of each substance to a drop each of water, vinegar, and iodine. Secretly mix two of the powders. Ask students, "How can we test to find out what they are?" Explain that physical and chemical tests similar to these are used to identify many unknown substances.

3. INDIVIDUAL ATOMS ARE IN CONSTANT MOTION, HAVE A NEUTRAL CHARGE, AND ARE MADE UP OF EVEN SMALLER PARTICLES: ELECTRONS (NEGATIVE CHARGE), PROTONS (POSITIVE CHARGE), AND NEUTRONS (NEUTRAL CHARGE). ATOMS OF DIFFERENT ELEMENTS HAVE A UNIQUE COMBINATION OF PROTONS, ELECTRONS, AND NEUTRONS.

- Show examples of several of the elements that typically exist as pure substances in our environment. Ask students to make a chart showing the symbols of the elements and examples of where they are used: e.g., Al

(aluminum)—foil, containers; Fe (iron)—cans, cars; C (carbon)—diamond, graphite, charcoal. Start a classroom element collection and have students keep a record. Students will begin to understand how elements are the building blocks of all matter.¹

¹Alvarez, Goeppert-Mayer

- Discuss how atoms can become electrically charged by gaining or losing electrons; then select a low-humidity day, inflate two balloons, tie a cotton thread or string to each, and rub both balloons on your clothing or hair. Both balloons will have a positive charge (electrons were rubbed off) and will repel each other when suspended and brought near each other. Next, touch several places on one balloon to a wall (electrons will leak back on) and bring the suspended balloons near each other again; they will attract. Help students understand that loss or gain of electrons by, for example, friction or contact can cause substances to become electrically charged, thus attracting opposite charges and repelling the same charges. Finally, have students research the formation of lightning.¹

¹Franklin, Millikan

4. MATTER CAN EXIST IN ONE OF THESE THREE PHASES: SOLID, LIQUID, OR GAS. A SOLID CAN BE CHANGED TO A LIQUID AND A LIQUID TO A GAS (EXAMPLES OF PHYSICAL CHANGES) BY APPLYING HEAT, WHICH INCREASES THE SPEED AT WHICH ATOMS MOVE AROUND.

- Demonstrate how a substance can change from one phase (state) to another by placing an ice cube in an open pan. After the ice cube melts, discuss what has happened (as the molecules vibrated faster, they moved out of their fixed positions and could slide over each other). Next take the pan and place it in direct sunlight for about an hour (as the molecules vibrate faster, they bounce up into the air and become separate gas particles). Discuss ways one could stop a cube from melting; then experiment.

Next, discuss ways to make the cube melt faster; then experiment. Students should now understand how changes in heat content (temperature) can cause changes of phase. Have students explain in their own words or role play how water goes from one state to another.¹

Advanced students may wish to research a fourth state of matter called "plasma."

¹Kelvin

- Show how substances can go from the liquid to the solid phase (state) by placing a few crystals of salol on a microscope slide and heating the slide gently over an alcohol burner flame. After the crystals have melted, place the slide on a microscope or microprojector stage and let students observe crystals grow as the liquid cools and solidifies. This shows how as molecules slow down they attract each other and become locked in relatively fixed locations in the crystal structure.

5. CHEMICAL CHANGES CHANGE THE ATOMIC STRUCTURE OF MOLECULES, THEREBY PRODUCING NEW SUBSTANCES. EACH PURE SUBSTANCE IS CAPABLE OF A UNIQUE SET OF PHYSICAL AND CHEMICAL CHANGES WHICH ARE KNOWN AS ITS PHYSICAL AND CHEMICAL PROPERTIES.

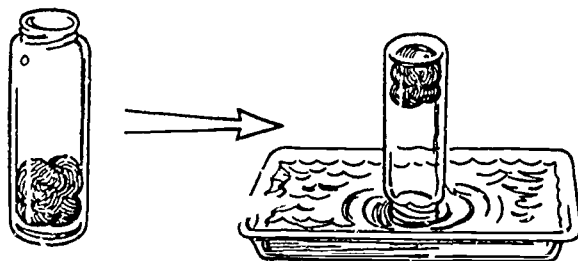

- Discuss chemical changes; then demonstrate one by stuffing a wad of steel wool into the bottom of a narrow olive jar. Wet the steel wool slightly. Invert the jar and place it in a shallow pan of water slightly higher than the jar opening. In a few days, students will note the rise of water in the jar as the oxygen is consumed. Have them examine the rusted steel wool and compare it with unrusted steel wool. Help them

understand that this is a chemical change in composition and properties; the steel wool cannot be returned to its original form by ordinary physical means.

- Describe how chemical changes may produce new substances with very different properties. Have student teams put two spoons of baking soda in a large ziplock bag and carefully add an upright paper cup half filled with vinegar. Have them squeeze most of the air out of the large bag and seal it carefully. They then invert the bag and observe the chemical reaction that occurs when the two substances mix. Have them write a description of the changes; then discuss how scientists develop many new products by understanding and using a variety of chemical changes.

6. CARE MUST BE TAKEN WHEN HANDLING CHEMICALS THAT ARE POISONOUS, FLAMMABLE, CORROSIVE, OR VERY REACTIVE.

- Discuss fire as a chemical change; then ask students to identify frequent fire hazards in a home such as oily rags in a garage, heaters too close to curtains, and frayed wires. Have students develop a sample fire safety check list and then go on a scavenger hunt at their home to find all unsafe hazards, discussing with their parents how to correct them as soon as possible. Emphasize personal responsibility for creating and maintaining a safe-from-fire environment.
- Describe the dangerously corrosive nature of acids and bases. Then distribute about ten strips per student of neutral litmus paper. Have students go on an "Acid/Base/Neutral Scavenger Hunt" at home (or school). Have them list each substance they test and record the color the litmus paper turns. Red/Pink = Acid; Purple/Blue = Base; No Change = Neutral. Discuss how some weak acids and bases may be foods (vinegar, etc.), while strong ones (drain cleaners, etc.) can be used to help us but may be very dangerous and should not be mixed with other chemicals that may create dangerous fumes, etc.

B. ENERGY

1. ENERGY IS NECESSARY TO DO WORK AND CAUSE CHANGES IN MATTER.

- Discuss energy and how it is used to do work. Then demonstrate a solar or battery-powered motor, radio, toy, or hand calculator. Show that a source of energy, such as light or the chemical energy of the battery, is necessary for the device to operate (do work).

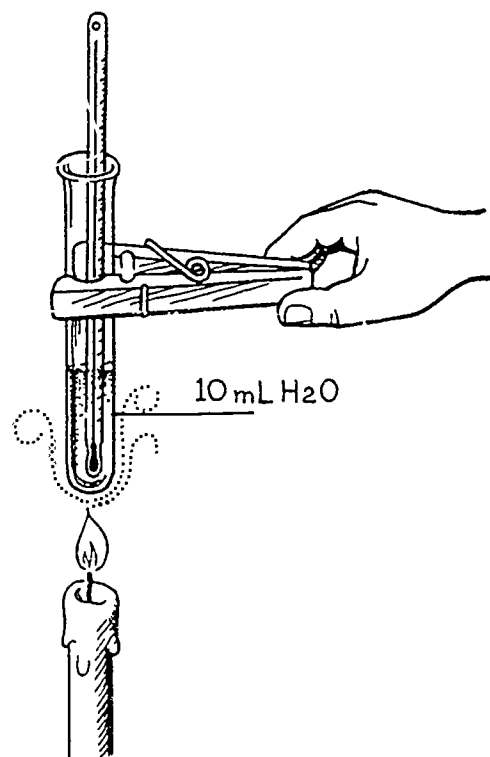

- Students can learn how energy can cause physical changes in matter by calculating the calories of heat absorbed by water as its temperature is increased. Have them add 10 mL of water to a large test tube and use a Celsius scale alcohol thermometer to measure/record the water temperature; then they heat the test tube with a candle for exactly 15 seconds. Finally, they carefully stir the water with the thermometer and measure/record the new temperature. Tell them it takes 1 calorie of heat energy to raise 1 g (1 g is about equal to 1 mL or 1 cc) of water 1 degree Celsius in temperature (it

takes 1,000 of these "small" calories to equal 1 "large" calorie of food energy). Students can now determine the amount of energy (in calories) the water absorbed. They will have experienced and documented how energy (the candle flame) can cause a change (temperature increase) in other matter.

2. DIFFERENT FORMS OF ENERGY (LIGHT, HEAT, ELECTRICITY, ETC.) CAN BE CONVERTED FROM ONE TO ANOTHER.

- Show the conversion of energy from one form to another by taking two tin cans (soup, juice, coffee or...) and stripping off the labels. Spray paint one can black, and leave the other one shiny. Fill both cans with water and let them sit in the sun for 20 minutes. Use an alcohol thermometer to measure/record the temperature before and after exposure to the sun. Discuss the question: "In which can was light (solar) energy changed to heat energy more efficiently?" The data will prove the black one did.
- Tell students that series of several different energy transfers may lead to an observed energy result. Ask them to rub their hands together and feel the heat build up. Have them trace the energy transfers; if necessary, suggest that the sun (light) energy became food (chemical) energy, then became mechanical (rubbing) energy, which became heat (from friction) energy. Challenge them to trace other series as in building a road, flying an airplane, etc.

3. ENERGY SOURCES AND TRANSFORMATION OF ENERGY ON EARTH CAN BE TRACED BACK TO THE SUN'S ENERGY AND ARE EITHER RENEWABLE OR NONRENEWABLE. CARE AND CONSERVATION IN THE USE OF ENERGY AND OTHER NATURAL RESOURCES IS AN ETHICAL CONCERN OF EVERYONE BECAUSE THESE RESOURCES ARE IN LIMITED SUPPLY.

- Conclude a discussion of energy sources and transformations by challenging students to study "The Making of a Ham-

burger." If necessary, suggest they include the food for the steer, the fuel for the tractor, the electricity for the freezer, etc. More than one component may come originally from the sun's energy. Have them construct a mobile or a diagram depicting the various sources and transformations. Then discuss the complex series of transformations involved in building a home, building and riding their bicycle, etc.

- Define the difference between renewable (sun, wind, etc.) and nonrenewable (coal, oil, etc.) sources of energy. Form student teams to gather information and select one of their members to report (in a panel presentation) ways of conserving a particular nonrenewable source of energy. Help the class realize the ethical concerns people become aware of as particular energy sources become nearly used up.⁴

⁴Social Studies

C. MECHANICAL ENERGY

1. FORCE IS A PUSH OR A PULL. GRAVITY IS A FORCE THAT ATTRACTS ALL OBJECTS. FRICTION IS THE FORCE THAT RESISTS THE MOTION OF OBJECTS.

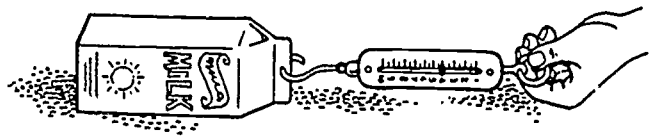

- Help students experience the meaning of friction by having them attach a spring scale to a brick or a milk carton filled with sand. Then as they pull it over different surfaces, such as cement, rug, dirt, etc., have them make a chart to record the amount of force needed. The class may depict these data with a bar graph or a list in order from most to least friction. The greater the friction, the greater the force needed to pull the object.

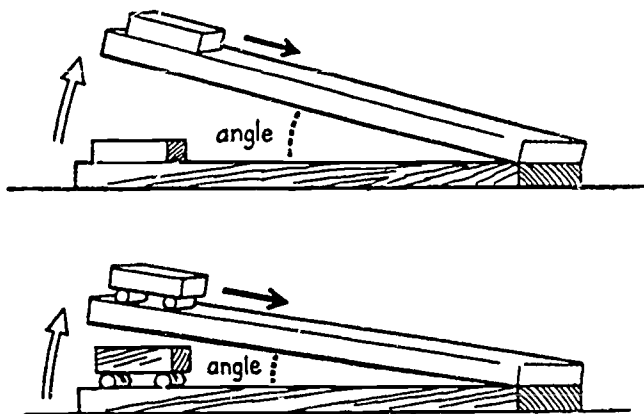

- Review the concept of friction; then demonstrate the effect of wheels added to an object to be moved. First, put a block of wood on a flat board. Raise one end of the board until the force of gravity causes the block to slide and measure the height and/or angle of the board. Next, put two round (cylindrical) pencils or dowels under the block; again, measure the height and/or angle of the board when the block begins to move. Wheels reduce friction, thus conserving energy and making the object (block) move easier.

2. WORK IS DONE WHEN A FORCE IS USED TO MOVE AN OBJECT. SIMPLE AND COMPLEX MACHINES MAKE USE OF MECHANICAL ENERGY TO DO WORK.

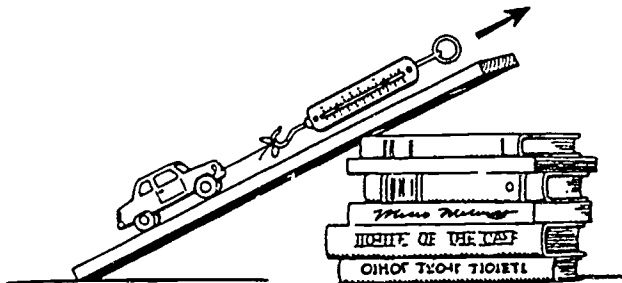

- Clarify that work is done only when a force on an object actually moves it by showing how a simple machine such as an inclined plane can vary the force needed to do work. Tie a string to a toy car and attach the string to a spring scale. Lift the car and record the scale reading. Set up an inclined plane (1-m board with one end resting on a stack of books) and pull the car up the plane using the spring scale. Record the scale reading. Change the angle of the plane and repeat, recording the scale reading. Discuss the

differences in scale readings and how the inclined plane made lifting the car easier.

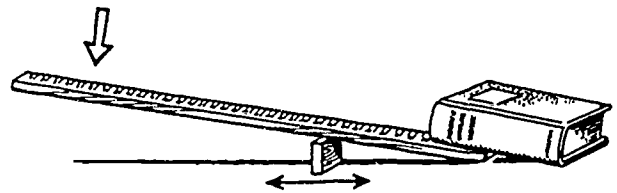

- Challenge students to reduce the force needed to move an object by using a lever. Have them use a meter stick pivoted on a rubber stopper fulcrum to lift a book. Move the rubber stopper fulcrum to different positions. Experiment to see which position requires the least effort (force) to lift the book. Then have the students draw diagrams to show when a small effort or a large effort is needed. When the fulcrum is close to the object, less effort is needed.

D. HEAT ENERGY

1. TEMPERATURE, THE NAME FOR HOW HOT THINGS ARE, MEASURES HOW FAST THE MOLECULES OF A SUBSTANCE ARE VIBRATING (THEIR KINETIC ENERGY).

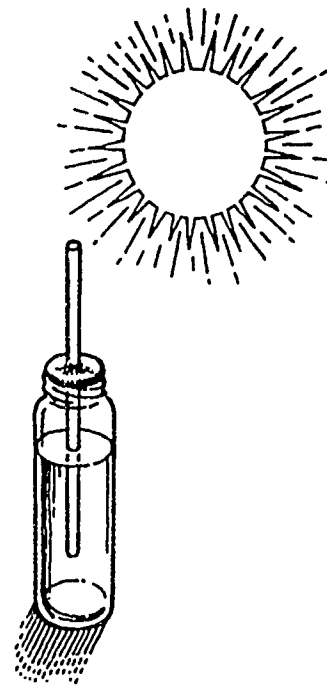

- Discuss how a thermometer measures temperature; then have students make a

thermometer. Have them almost fill a narrow olive jar with colored water and put a straw halfway into the jar, plugging the jar's opening and sealing around the straw with clay. Have them place the jar in the sun and observe what happens to the water level in the straw as the water gets warmer. Help them understand how the molecules vibrate faster and push farther apart as they get warmer.¹

¹Kelvin

- Clarify the difference between the temperature and the heat content of substances by heating one small and one large nail on a hot plate for 5 minutes, thus making each the same temperature. Prepare two equal size small cans half filled with room temperature water. Then use tongs to drop one nail into each container. Have students determine which water sample gets warmer and, therefore, which nail had more heat content. Thus, two objects at the same temperature but different masses may contain different amounts of heat energy.

2. HEAT ENERGY WILL BE TRANSFERRED AND CAN BE USED TO DO WORK WHEN SUBSTANCES ARE NOT AT THE SAME TEMPERATURE. HEAT TRANSFER CAN BE ACCOMPLISHED BY CONDUCTION, CONVECTION, AND RADIATION.

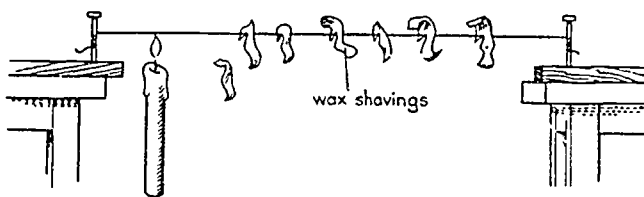

- Discuss heat flow from one substance to another; then demonstrate how heat is conducted through a wire. Carve wax shavings from a candle and place them along a wire suspended between two metal supports. Then heat near one end of the wire with a candle. Ask students to record their observations. The wax shavings melt and drip in order, beginning with the shaving nearest the candle flame.

- Show that insulating materials slow down heat transfer by heating a quantity of water and pouring equal amounts into containers of the same size and shape. Have students surround each container with a different substance such as vermiculite, newspaper, Styrofoam, sand, air, or cloth. Ask them to predict which will be the best insulator. Have them measure the temperature in each container at equal intervals throughout the day and graph the results. Help the students hypothesize that heat transfer by conduction, convection, or radiation was reduced by each insulating method.

E. LIGHT ENERGY

1. LIGHT TRAVELS VERY RAPIDLY IN STRAIGHT LINES FROM ITS SOURCE AND MAY BE REFLECTED, REFRACTED, OR ABSORBED.

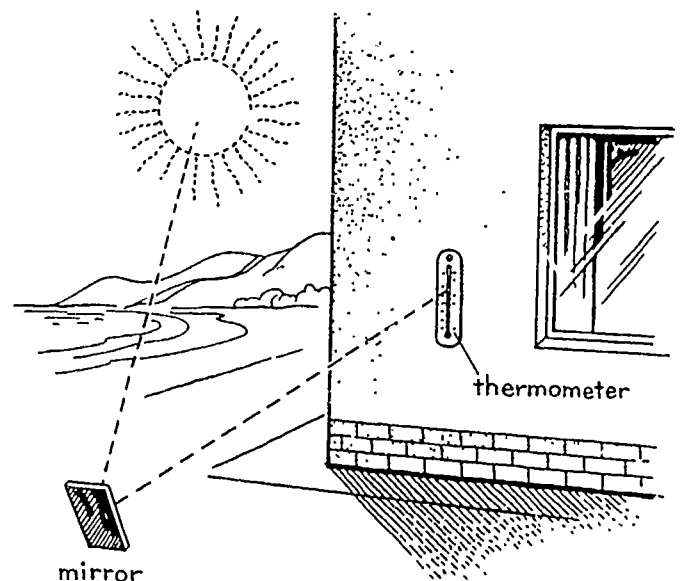

- Show how the energy carried by a light beam may be reflected by having students tape a thermometer to an outdoor wall on a shaded part of the building. Then, with students standing in the sunlight and using a mirror, have them reflect sunlight onto the thermometer and record any changes in temperature. They may experiment with two, three, or four mirrors focused on the

same thermometer and record temperature changes, graphing the results. Help them see that light must travel in straight lines, yet can bounce (reflect) off certain objects.

SAFETY: Students must use mirrors carefully in order not to reflect sunlight into classmates' eyes.

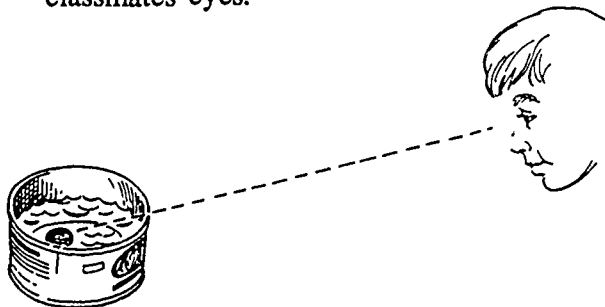

- Discuss light refraction (bending); then challenge students to predict the position of an object in water when viewed from an angle above the water. Form two-student teams; have one member place a penny in the bottom of a tuna fish can. The other member positions himself or herself so the penny remains just out of sight. The first member adds water to the can; the second member observes what happens without moving his or her head, records the results, and explains what happened with a diagram. Because the light beam travels slower in water, it bends and makes the penny appear higher than it is.

2. WHITE LIGHT IS A MIXTURE OF COLORS THAT CAN BE SEPARATED INTO A SPECTRUM BY A PRISM.

- Discuss the colors in white light. Then have students blow soap bubbles in the sunlight. They may observe the different colors as sunlight passes through different parts of the bubble. Ask them to record their observations by creating a color drawing with watercolors, crayons, or ... Help them realize that raindrops may act similarly to soap bubbles when a rainbow is observed in nature.

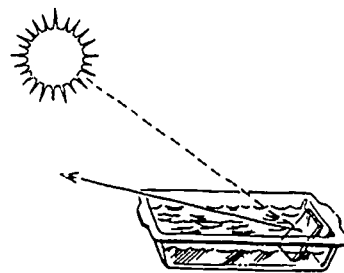

- Demonstrate how a "water" prism can separate the colors in white light by half-filling a glass baking dish or cake pan with water and putting it in the sun. Place a small mirror in the water and lean it against one end of the dish at an angle so it reflects a sunlight "spectrum" from the submerged part of the mirror onto a wall. Ask a student volunteer to stir the water gently so the class can observe what happens to the colors. The "rainbow" of colors will move around in random patterns.

3. CONCAVE MIRRORS CAN FOCUS LIGHT BY REFLECTION; CONVEX LENSES CAN FOCUS LIGHT BY REFRACTION.

- Demonstrate the difference between a concave and convex lens. First, have students look through the bottom of a thick drinking glass (a concave lens); everything appears right side up and smaller. Next, have students place a drop or two of water onto a comic strip page. The drop has a convex or bulging shape which causes objects to appear larger, or magnified. Finally, have students make a simple telescope by placing a concave lens near their eyes and a convex lens beyond them. Have them keep moving the convex lens toward and away from the concave lens until they see a magnified image.
- Ask students how a design engineer could determine where to put the food when developing a concave dish solar cooker. Then have a student volunteer demonstrate how to find the distance at which a concave shaving mirror focuses light. Have the students reflect sunlight onto a white card; then move the mirror closer or farther away until the light comes to a point. Measure the distance between the mirror and card (called

the "focal distance"). Ask the class: "Will other concave mirrors have the same focal distance?"

SAFETY: Do not allow the concave mirror to reflect sunlight into anyone's eyes.

4. THE SPECTRUM OF VISIBLE LIGHT COLORS IS THE ONLY PART OF THE ELECTROMAGNETIC SPECTRUM OF ENERGY MOVING THROUGH SPACE THAT OUR EYES ARE ADAPTED TO DETECT.

- Discuss the visible light spectrum. Then shine sunlight through a prism onto white paper. Note the locations of the different colors of the spectrum. Then hold a thermometer bulb end just beyond the red end of the spectrum. Explain that invisible infrared light waves cause the thermometer temperature to rise.
- Have students experience one way our eyes see color by asking them to stare intently at a colored square of paper for 1 minute; then switch their viewing to a piece of white paper. Have them describe the after-image they see in the complementary color. Explain that their eyes have chemicals that respond to certain colors; staring at one color used up that chemical so that color was "missing" from the white light reflecting off the white card.

F. SOUND ENERGY

1. SOUND IS A FORM OF ENERGY CONSISTING OF RAPID BACK AND FORTH MOVEMENT OF PARTICLES (VIBRATING OBJECTS). FREQUENCY, OR PITCH, IS THE NUMBER OF VIBRATIONS PER SECOND; LOUDNESS DEPENDS ON THE INTENSITY (AMPLITUDE) OF THE VIBRATIONS.

- Discuss various ways of producing sounds. Then have students position a plastic ruler so that half its length extends beyond the table edge; they hold the other half firmly to the table. Have them pluck the free end and note the sound as the ruler vibrates. Next, have them vary the length

of the ruler part that sticks out over the table edge and pluck the end again. Ask them to record what happens to the speed of the vibrations and the pitch with each ruler's position...

- Help students experience sound as vibrating matter by having them experiment with several tuning forks. Ask them to strike a tuning fork with its rubber mallet and, holding it next to their ears, twist it back and forth, noting the directionality of the sound. Have them strike the fork again and touch its base behind their ears, to their teeth or lips, or on top of their heads to feel the vibrations. Finally, have them strike the fork and touch its base to a paper cup or index card. The cup or card acts like a loudspeaker to amplify the sound.

2. SOUND TRAVELS AT DIFFERENT SPEEDS IN SOLIDS, LIQUIDS, AND GASES, BUT SOUND DOES NOT TRAVEL THROUGH A VACUUM. SOUNDS CAN BE DIRECTED, REFLECTED, AND ABSORBED.

- Discuss the transmission of sound through matter. Then place a ticking clock in an unlined metal waste basket and measure how far away the sound can still be heard. Then line the basket with thick cloth and measure the hearing distance again. Ask the students how the distances compare. Then ask them to suggest other ways the sound intensity could be varied.
- Ask students which they think sound will travel faster through: air or string? Have them cut a piece of heavy-duty string about 1 m (1 yd.) long and then tie two eating utensils (knife, fork, spoon) about 2.5 cm (1 in.) apart in the center portion of the string. Then have them place both ends of the string into the outer portion of one of their ears, letting the utensils swing freely so they collide with each other making a chime-like sound in their ears. Finally, have them compare the sound when the string is removed from their ears and the air is conducting the sound. Ask them whether their original prediction was correct.

3. THE HUMAN EAR IS SENSITIVE TO A LIMITED RANGE OF FREQUENCIES WHICH ARE RECEIVED AND TRANSMITTED TO THE BRAIN THROUGH THE AUDITORY NERVE.

- Help students learn the structure and function of the ear by having them research the parts of the ear and how it transmits sound to the brain. They may wish to draw a labeled diagram or build a clay model. Ask them also to research and graph the different range of frequency levels a variety of animals can hear compared to that of a human, as well as the different decibel ratings of a variety of sound sources.
- Demonstrate the range of frequencies that the human ear can receive. Fill four soda bottles with water at different levels. Using a pencil to tap the bottles, have students arrange the bottles in order from lowest to highest pitch. Next, have students blow across the top of each bottle and rearrange the bottles, if needed, in order from lowest to highest and compare the results to those of the first activity. Challenge the students to compose a tune or make rhythm instruments that produce different frequency ranges.

G. ELECTRICITY and MAGNETISM

1. A MAGNETIC FIELD, CAPABLE OF EXERTING FORCE ON MAGNETIZABLE SUBSTANCES, EXTENDS FROM THE POLES OF A MAGNET. THE EARTH ACTS AS A LARGE MAGNET, WHICH ENABLES US TO USE A MAGNETIC COMPASS.

- Ask students whether they think it is possible to "see" the shape of a magnetic field. Then place a bar-shaped magnet on an overhead projector; cover it with a sheet of acetate or Saran wrap. Next, sprinkle iron filings on top of the cover. Ask students to note the magnetic force at the poles. Draw a circle over the bar magnet to simulate the earth. Have students observe magnetic north. Students should begin to understand how the use of a compass helps ship captains navigate across wide oceans.

- Discuss how a horseshoe magnet differs from a bar magnet; then have students cut different shaped magnets out of a rubberized magnetic sheet. Have them cover their shapes with Saran wrap and sprinkle iron filings on top to study the shape of the magnetic field. These magnetic patterns can be saved permanently by spraying the design lightly with paint or clear plastic sealer; or, have students make drawings to record each shape. Students should begin to understand how knowledge of different field shapes could help a design engineer develop a new piece of equipment.

2. A STATIC ELECTRIC CHARGE MAY BE PRODUCED ON OBJECTS RUBBED TOGETHER. THERE ARE TWO KINDS OF ELECTRIC CHARGES, POSITIVE (+) AND NEGATIVE (-); LIKE CHARGES REPEL AND UNLIKE CHARGES ATTRACT EACH OTHER.

- Ask students how many of them think they have ever personally created a static electric charge. Then give students a clear plastic cup, some puffed rice, Saran wrap, and a rubber band. Have students put the puffed rice in the cup, cover it with Saran wrap, and secure it with the rubber band. Then have students rub the Saran wrap-covered cup on their hair or clothing until the puffed rice is attracted to the Saran wrap when the cup is sitting on the desk. Ask the students to hypothesize why the puffed rice sticks to the Saran wrap. Help them comprehend that electrons were transferred from one place to another when the cup was rubbed against certain materials.
- Discuss how static electric charges are formed; then have the students observe the attraction and repelling of sawdust. Obtain fine sawdust or pencil shavings from the pencil sharpener. Have students place some in a small container; then rub any plastic object (pen, comb, plastic straw) with a cloth or paper towel. Have students hold it near the sawdust pile and observe the sawdust being attracted. Then have students hold the plastic upright and observe the repelling of many sawdust particles; ask them how they could explain

what they observed. Help them remember that unlike charges attract each other while like charges repel each other.

3. AN ELECTRIC CURRENT CAN BE MADE TO MOVE ALONG A CONDUCTOR IF THERE IS A COMPLETE CIRCUIT.

- Show students how a wall switch or lamp switch "turns the lights on" when it completes the circuit. Then have students test a variety of ways to make a circuit using a battery, one wire, and a light bulb. After each student can make the bulb light, groups of students can combine equipment to form larger circuits. Help students understand that some ways of creating circuits can make the bulb burn brighter (series), and other ways make several bulbs burn at the same brightness (parallel).²

²Electricity

- Discuss how some materials allow electrons to flow (conductors), and other materials do not allow electrons to flow (nonconductors or insulators). Have students test materials by constructing an open circuit (see diagram).

Then have students use a variety of materials to close the circuit. These materials can then be classified as "conductors" if the light bulb goes on or "nonconductors," i.e., "insulators," if the light bulb does not light.

4. A MAGNETIC FIELD PRODUCES AN ELECTRIC CURRENT IN A CONDUCTOR THAT MOVES THROUGH THE FIELD. ALSO, AN ELECTRIC CURRENT MOVING THROUGH A CONDUCTOR PRODUCES A MAGNETIC FIELD AROUND THAT CONDUCTOR.

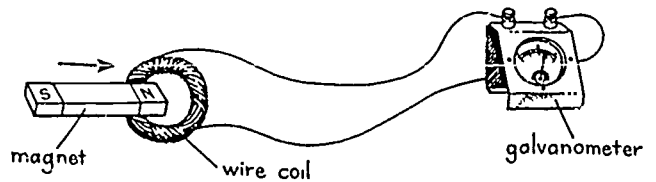

- Demonstrate how a conductor moving through a magnetic field can have an electric current created in it by making a small coil of insulated copper wire and connecting the two ends to a small galvanometer. Next, obtain a strong magnet and move the coil of wire through the magnetic field near one of the poles slowly and then at different speeds. Students will be able to observe the needle register a current flow that depends on the number of turns of wire in the coil and the speed of the coil through the magnetic field.

- Help students find out how an electric current can produce a magnetic field by having teams build an electromagnet. Give each team a large nail, insulated copper wire, and a battery. Have the teams coil the wire around the nail and attach the wire ends to the battery. This will produce an electromagnet that will pick up paper clips. Students can test several variables: (1) different amounts of wire in the coil; (2) more batteries; and (3) more nails or no nail. Ask students to hypothesize about why each variable they test causes its results.

BIOLOGICAL SCIENCE (7-8)

A. CELLS, GENETICS, and EVOLUTION

1. KNOWLEDGE OF THE CELL INCLUDES THE BASIC CONCEPT OF THE CELL THEORY, THE STRUCTURE AND FUNCTION OF THE MAIN PARTS OF TYPICAL PLANT AND ANIMAL CELLS, AND THE PROCESSES OF DIFFUSION AND OSMOSIS AS THEY RELATE TO THE TRANSPORT OF MATERIALS BETWEEN AND WITHIN CELLS.

- Use models, slides, videos, and text to help students compare the structure and function of the major parts of both plant and animal cells.² Supply multicolored construction paper, scissors, and glue. Have students design and label a "typical" cell and on completion present their cell to the class.⁴ At the conclusion of the exercise, ask students to hypothesize why plants have a cell wall and animals do not. Place all hypotheses on the chalkboard and discuss them, with an emphasis on the concept that although plant and animal cells are similar, differences based on inferred patterns of evolutionary development exist.

²Cell Theory

⁴Art (See page 2 for an explanation of entries like these.)

- Begin class with demonstrations and discussions of diffusion and osmosis. Diffusion demonstrations might include spraying perfume in one part of the room or adding a small amount of dye to a large container of water. Osmosis demonstrations might include filling a semipermeable membrane (dialysis tubing) with a starch solution and placing the membrane in an iodine and water solution. Following the demonstrations, hand groups of students a sheet of paper with the following statements on it:
 - Case A: 10 saltwater fish are placed in fresh water. What happens?
 - Case B: 10 freshwater fish are placed in salt water. What happens?

Ask students to communicate with one another in their group and use the infor-

mation obtained during the demonstration, and discussion to develop a written group prediction of what might happen to the fish in each case and why. When students appear to be finished, add one more assignment. "Hypothesize how some fish can live in both fresh and salt water." (In the case of fish, the kidneys and gills act as osmoregulatory organs. This can lead to some key questions for students to contemplate prior to a later study of organ systems.)

2. THE RELATIONSHIPS WHICH EXIST AMONG CELLS, TISSUES, AND ORGANS CAN BE IDENTIFIED, AS CAN THE ENERGY REQUIREMENTS OF UNICELLULAR AND MULTICELLULAR ORGANISMS.

- Discuss with students the implications of eating ten candy bars per day for ten days. In addition to the obvious health and nutritional factors, approach the topic from the physiological and anatomical points of view. If possible, obtain a model of the human digestive system from a local high school. Otherwise, use an overhead projector while each student is given a photocopy of the digestive system. Trace the candy bar through the body, taking special care to observe what happens at the cellular, tissue, and organ levels. When finished, have students use their drawings to compare what would happen if they ate ten cookies per day for ten days instead of candy; and then have students write an essay relating the digestive misadventures of a cookie eater, focusing on the concept that although food groups provide the energy needed by animals, some food groups don't provide "efficient energy."⁴

⁴Health, English-Language Arts

- Discuss the energy sources for plants and animals. Set up a healthy hay infusion and obtain geranium plants. Have students observe both, using a microscope to focus on cells, tissues, and organs. (Teachers may

also want to use prepared slides.) After preliminary observations, place the hay infusion and geranium plants in the dark. Follow the same observation procedure every other day for two weeks. Keep careful notes, including dates. At the conclusion of time, have students write an analysis of the influence of light on plants and animals, realizing that even though animals do not use light directly as an energy source, their survival is indirectly linked to its presence.

3. MITOSIS AND MEIOSIS ARE BASIC CONCEPTS INHERENT IN THE UNDERSTANDING OF SEXUAL AND ASEXUAL CELL DIVISION; FURTHERMORE, THE ROLES OF GENES AND CHROMOSOMES—AND THE PRINCIPLES OF DOMINANCE, RECESSIVENESS, AND MUTATIONS—ARE ALL ESSENTIAL FACTORS IN DETERMINING CHARACTERISTICS.

- Bring some bread dough to class and have students watch it rise. Have students hypothesize the reasons this phenomenon occurs. Obtain dried yeast and place it in lukewarm water (35° C) for 30 minutes. Place drops of the water/yeast mixture on a depression slide and use a microscope to observe that asexual cell division in yeast occurs by budding.
- Discuss the processes of mitosis and meiosis by use of a video and text. Have students use several colors of clay to build models of chromosomes, polar bodies, and spindle threads arranged to show stages in mitosis and meiosis.⁴ These models will illustrate that mitosis is a process that results in replication of the number of chromosomes, whereas meiosis is a process that results in a reduction in the number of chromosomes.

⁴Visual Arts

4. THE BASIC CONCEPT OF NATURAL SELECTION REFLECTS THE SIGNIFICANCE OF FOSSIL AND GEOLOGIC EVIDENCE SUPPORTING THE EXTINCTION OF PREVIOUS ORGANISMS AND THE EVOLUTION OF NEW, MORE COMPLEX AND DIVERSE ORGANISMS FROM SIMPLER FORMS OF LIFE.

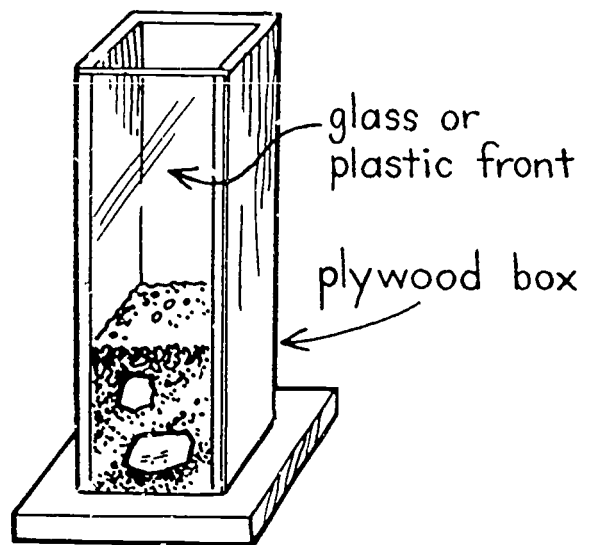

- At the beginning of the year, discuss time scales with students and build a plastic "core sampler" for use during the year. Each day, have students drop a measured amount of sand into the box. For holidays and special school event days, have students drop an artifact of that event into the box. At the end of the year, students observe layering and infer the passage of time periods of varying lengths between events. Data can be extrapolated to represent long periods of time and inferences made in terms of geologic time scales using powers of 10.⁴ Have students conceptualize that relative ages of fossils are determined in several ways, including the order in which the strata of sediments that contain them were deposited.^{1,2}

¹Mendel, Crick, Darwin

²Natural Selection, DNA, Evolution

⁴Mathematics

- Discuss the environmental factors that can lead to changes in animal populations. Give examples, such as subspecies variations of lizards throughout California or changes in fruit fly populations in nature. Randomly scatter one hundred 3-cm pieces of several colors of yarn ("wooly worms") on a large grassy area. Have students pretend to be birds gathering worms for food. Each bird can carry only one worm at a time to its nest (a plastic bag on the perimeter of the grassy area). After a given

time, the number of each color of worm is recorded. Have students use their data to formulate explanatory models for the change in the color of the woolly worms. Follow by reading the story of the changing color of peppered moths in England. From the experiment it can be inferred that natural selection is the process through which beneficial changes in characteristics that come about through variation and mutation tend to persist over generations, while harmful characteristics and changes tend to be eliminated.

B. PLANTS

1. PLANTS ARE UNICELLULAR OR MULTICELLULAR ORGANISMS THAT LIVE BY PERFORMING COMMON PHYSIOLOGICAL FUNCTIONS, INCLUDING PHOTOSYNTHESIS, RESPIRATION, AND TRANSPIRATION.

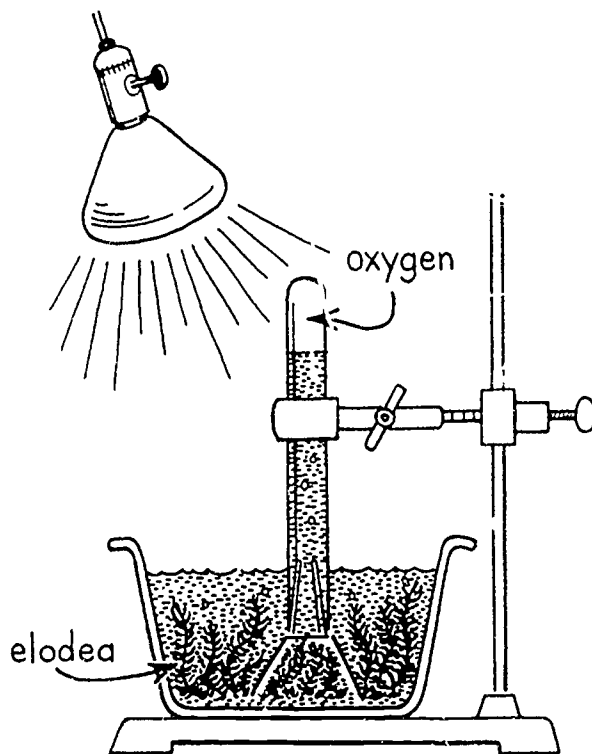

- Review and discuss the process of photosynthesis with students.² Place a glowing splint in a test tube of oxygen and another splint in carbon dioxide and observe what happens. Have groups of students immerse

a large piece of elodea (available at aquarium shops) in an aquarium filled with water. Submerge a funnel over the plant and then place a test tube full of water upside down over the end of the funnel. Illuminate with a bright light. Have students observe the displacement of water and analyze the gas produced by the method used in the demonstration. It will be apparent that photosynthesis renews oxygen in the atmosphere and in the water.

2Photosynthesis

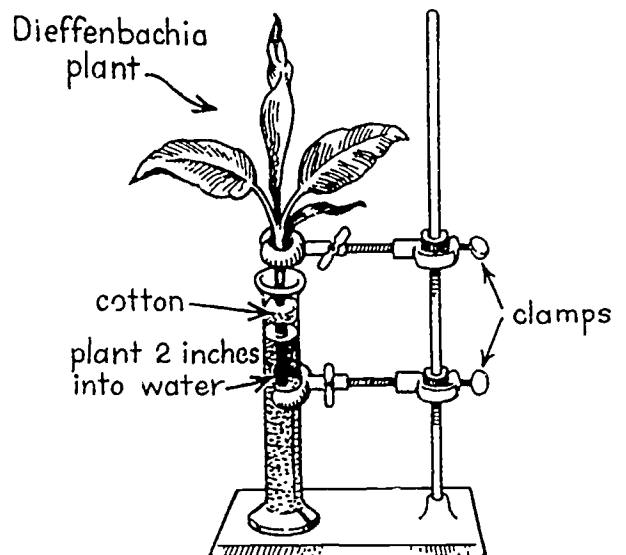

- Engage students in a discussion of the movement of materials through a plant and what happens to plants during varying weather conditions, such as hot windy days, a humid environment, and extreme cold. Have students work in groups. Have students cut off a series of growing plants (e.g., dieffenbachia) at the base where they enter the soil and secure the specimens with a clamp on a ring stand. Pack cotton around the plants and seal with warm paraffin. Make comparisons of changes in the water level hourly. For some plants, vary the conditions and record the results using grow lights and fans; for others, create a humid or cold environment. Experimentation will show variations in the amount of water and dissolved minerals rising up to the leaves. Conclude by having students write a group research paper which discusses the results of manipulating variables.

2. PLANT ADAPTIONS TO MINERAL REQUIREMENTS AND TROPISMS INFLUENCE SURVIVAL IN A VARIETY OF PHYSICAL ENVIRONMENTS.

- Ask students if they have ever planted seeds and, if so, what seeds need to germinate. Continue by asking students what plants need to grow once they have germinated. Keep a posted record of answers. Provide each student with Styrofoam cups or small plastic pots. Use some inert anchoring medium, such as vermiculite, and add two seeds to each pot. Split the class into thirds and use tap water with one group, distilled water with the second group, and a hydroponic solution with the third group. Have students keep records of the time of germination and the amount of daily growth after germination. Keep all class data posted. When appropriate, have students organize the data and draw inferences about the effects of each solution on (1) germination; and (2) growth after germination. Have students discuss and write group reports which focus on essential nutrients.⁴

⁴English-Language Arts

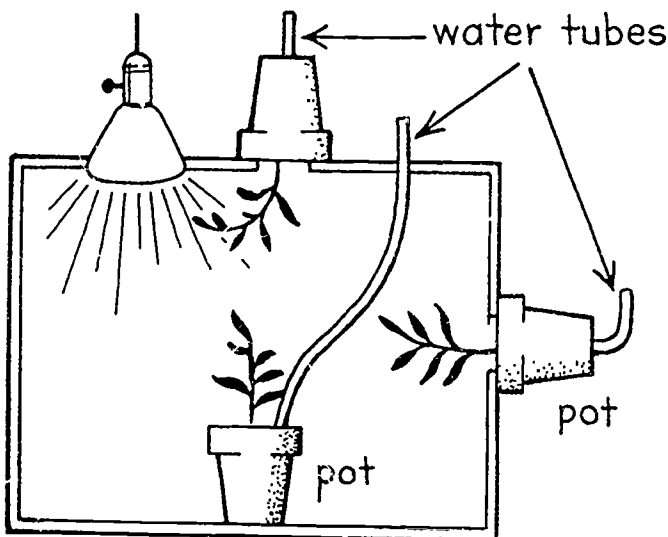

- Ask students what would happen if they went home and turned all their potted plants upside down, placed "collars" around the top of the pots so the soil would stay in,

hung them in a breezeway so the vegetative parts would not be disturbed, and watered them through the "bottom" pot hole? Have students draw a picture of what their plants would look like and what they think plants would look like in two or three weeks. Have student groups plant bean seedlings in vermiculite-filled pots and water them with a nutrient solution. Once the plants are established, orient the pots in different directions in a dark cardboard box. Cut a hole to allow light to enter from one corner. Observe roots and the vegetative parts of plants in two to three weeks. Review with students that in normal environments, the vegetative and reproductive parts of plants are positively phototropic and negatively geotropic, whereas the roots are negatively phototropic and positively geotropic. Conclude by asking students to write about and sketch plant life on a planet that they choose to create, formulating explanatory models based on their classroom experimentation.⁴

⁴Art, English-Language Arts

C. PROTISTS

1. PROTISTS REPRESENT A DIVERSE GROUP OF LIVING ORGANISMS, INCLUDING BACTERIA, PROTOZOA, ALGAE, AND FUNGI; THEY EXHIBIT WIDE VARIATION IN STRUCTURE, FUNCTION, HABITAT, AND LIFE ACTIVITIES—AS WELL AS ECONOMIC AND ENVIRONMENTAL SIGNIFICANCE.

- Have students discuss and read how various cultures have developed methods of making food taste better with protists. Included could be Middle Eastern bread, Scandinavian yogurt, Oriental soy sauces, and French cheeses. Organize a class project to make one or more food products requiring protists (e.g., root beer, yogurt, bread). Have students sample cultures microscopically and then write reports emphasizing the use of protists in various fermentation processes.¹

¹Fleming

- Have students view a film or video about algae. Continue with a discussion of different types of algae—from phytoplankton to large kelps. Place students in algae groups for the year and have each group select a "water source" near school that will be available for the year. Every other week, have students sample their source by observing drops under the microscopes. Have them draw all species and keep track of their numbers and relative sizes. As the year progresses, continually organize and compare data. Conclude by having students write team research papers in which they analyze their data and predict patterns for future years.

D. ANIMALS

1. THE MAJOR ORGAN SYSTEMS OF REPRESENTATIVE VERTEBRATES AND INVERTEBRATES EXHIBIT NUMEROUS SIMILARITIES AND DIFFERENCES IN STRUCTURE AND FUNCTION.

- Engage students in a discussion of the knights of old and their heavy armor.⁴ Have each student list the advantages and disadvantages of this armor and follow up with a discussion of the armor of the dinosaurs. Place around the classroom various invertebrates and vertebrates (e.g., sponges, jellyfish, earthworms, crabs, mussels, starfish, sharks, bony fish, and frogs). Have students walk around the room and sketch each specimen and hypothesize about its skeleton. By use of slides and drawings, discuss the skeleton of each representative specimen, emphasizing that the skeletal system of invertebrates and vertebrates exhibit numerous similarities and differences in structure and function.

⁴History-Social Science

- Discuss early classification systems. Place students in groups and have them practice the keying of different kinds of bottles or nails, based on similarities in structure. Next, give each group ten representative

samples of common invertebrates and vertebrates. Using major characteristics of each phylum and class, students develop a dichotomous key for each specimen. At the conclusion of the exercise, have the groups exchange "keys" to see whether they will work on the specimens.¹

¹Linnaeus

2. MOST ANIMALS REPRODUCE SEXUALLY. ALTHOUGH EMBRYOS OF SOME ANIMALS ARE SIMILAR IN THE EARLY STAGES OF DEVELOPMENT, THERE ARE MANY DIFFERENCES IN DEVELOPMENT BETWEEN EGG-LAYING AND PLACENTA-FORMING SPECIES.

- Ask someone from a poultry farm or pet store to come into class and discuss the incubation of chicken eggs and/or the development of baby mice. Procure an incubator and go through a daily discussion with the class of the stages of development of a chicken embryo, with an emphasis on the function of the egg. Meanwhile, also procure some male and female mice and go through the same discussion, with emphasis on the placenta. Have students keep careful records of dates. After hatching and birth, ask students to observe and collect information on the reproductive cycles of other egg-laying and placental classroom animals.
- Ask students whether they think they can always tell the difference between fish, amphibians, reptiles, birds, and mammals? Lead into a discussion of embryonic development of representative species. Assign groups of students various orders of vertebrates. Have them examine illustrations showing the embryonic development and mature appearance of their order. Have students compare the similarities and contrast the differences at various stages.

E. HUMAN BEINGS

1. HUMAN BEINGS EXHIBIT SPECIFIC CHARACTERISTICS WHICH PLACE THEM IN AN ORDER OF MAMMALS CALLED PRIMATES.

- Provide a period of time for students to read items in various books and articles (such as from *National Geographic*) on primates and primate behavior. Ask students to work in groups and make a list of the characteristics of primates. Have them follow this with a list of the characteristics of humans. Then have them compare the two lists and theorize why humans have been so successful on earth. Conclude with students drawing a picture of what humans might look like at some future time because of changing environmental conditions.⁴

⁴Art

- Provide a period of time for students to both read an item and review a film or video about the research of Jane Goodall. Discuss her work from both a biological and historical perspective.⁴ Have students individually select various areas of interest, such as social behavior, family care, intelligence, aggression, and use of tools, and write a research paper comparing apes and humans.⁴ Ask students to predict future patterns of behavior for each group based on their research.

⁴History-Social Science, English-Language Arts

2. MAJOR ORGAN SYSTEMS (E.G., RESPIRATORY, CIRCULATORY, DIGESTIVE, AND REPRODUCTIVE) EXHIBIT SPECIFIC STRUCTURE AND FUNCTION.

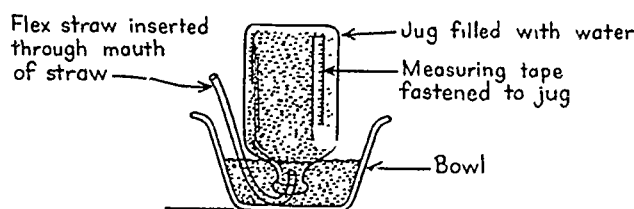

- Review with students how the lungs function and their anatomical structure. Next ask them how much difference they think exists in lung capacity between boys and girls, between smokers and nonsmokers, between athletes and nonathletes?⁴

Have students formulate experimental hypotheses and then use the apparatus shown above to collect data. When they are finished, help students to analyze the data statistically using calculators.⁴ Together as a class, have the students write a generalization based on the research.^{1,2}

¹Harvey

²Circulation of Blood

⁴Mathematics

- Discuss human heart rates and the effect of stimulants and depressants on heart rates. Obtain a culture of daphnia and have students work in groups or use a microprojector for a "class lab." First, have students obtain the normal heart rate for daphnia by tapping their pencil on paper to match the daphnia rate for 15 seconds, counting the pencil marks and extrapolating. (The rate for this organism is extremely high.) After obtaining an average rate, follow the same procedure after adding caffeine to some samples and nicotine to other samples. Have them compare the data and draw inferences for human populations.

3. IN ORDER TO MAINTAIN THE VALUES AND ETHICS OF SOCIETY, HUMAN BEINGS MUST ACT RESPONSIBLY WITH REGARD TO REPRODUCTION, FAMILY RELATIONSHIPS, AND MENTAL AND PHYSICAL HEALTH

- Ask students to choose between reading *The Chocolate War*, by Robert Cormier or *A Separate Peace*, by John Knowles. Place students in groups based on the book that they read.⁴ Have each group prepare a panel discussion for the rest of the class in regard to its book and its significance in terms of the present values, ethics, and peer pressure of the community.

⁴English-Language Arts

- Have students read the *Crito*, by Plato. Entertain a class discussion of the personal and social responsibility of a human being from a historical, Socratic point of view, as contrasted with the personal and social

responsibilities of human beings as perceived by students today.⁴ Have the class draw inferences and formulate explanatory models for changes in human behavior. Review that responsible attitudes and behaviors are important to individuals and society. These behaviors are especially important where permanent damage to an individual (or to society) may result, or where long-term effects are unknown.

⁴History-Social Science

F. ECOSYSTEMS

1. ECOSYSTEMS ARE COMPOSED OF LIVING ORGANISMS (SPECIES, POPULATIONS, AND COMMUNITIES) INTERACTING WITH ONE ANOTHER AND THE PHYSICAL ENVIRONMENT.

- Review with students various examples of marine, freshwater and terrestrial ecosystems. Based on the geographical location of the school, create a classroom ecosystem. The following example is for a coastal school: Help students set up a 10-gal. (38-L) marine aquarium. Add a rock with attached mussels, gooseneck barnacles, and a couple of bat stars. (Check with the Department of Fish and Game for permission to obtain these specimens.) These three organisms represent a classic intertidal community. Have students keep daily records of water temperature, salinity (using a simple hydrometer), and the various types of interrelationships that exist among the species. (Look for commensal scale worms on bat stars, parasitic copepods in mussel shells, and examples of mutualism among the three major species.) Have students keep records of the ecosystem over time and compare changes in the physical environment with changes in populations. Conclude by having students apply the knowledge they gained by writing a paper about how they would monitor an ecosystem in its natural environment.⁴

⁴English-Language Arts

- Write a definition for an ecosystem on the board and discuss ways in which students could monitor a section of the school yard for a year as their own "personal" ecosystem. Have students make rain gauges, anemometers, and various other pieces of equipment. Throughout the school year on a weekly basis, students should record data on all plant and animal life and keep careful records of all physical data (e.g., temperature, wind, rain, soil). Have them use a class bulletin board and keep field notebooks. At the end of year, have them write a class research paper analyzing all data and predicting future patterns for the ecosystem.⁴

⁴English-Language Arts

2. MATTER NEEDED TO SUSTAIN LIFE IN AN ECOSYSTEM IS CYCLED AND REUSED. MAJOR CYCLES INCLUDE THE CARBON CYCLE, NITROGEN CYCLE, AND WATER CYCLE.

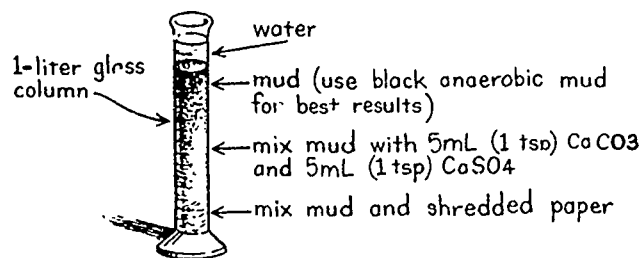

- Have students read about, review, and draw pictures of the various major cycles in which matter is reused. (Even though this concept may be scheduled for spring, spend some time on it during the fall.) Demonstrate for each class the procedure for making a Winogradski Column. When it is completed, set it in a window for the school year. Have students compare the growth on the light and dark sides of the column during the different seasons. Colors will change as organisms change. In the spring, review and draw again each of the major cycles and discuss these in

terms of the changes that have occurred throughout the year in the column.

- Use videos and software to assist in a discussion of various cycles of materials (especially the carbon cycle). Procure from a biological supply house, a local pond, or the marine environment a representative culture of diatoms and copepods. Have students observe these organisms under the microscope at various magnifications and draw and label them.⁴ Following this introduction, carefully and slowly review photosynthesis in a diatom and respiration in a copepod. In a diatom, the energy trapped by the chloroplast is used to rearrange the water and carbon dioxide molecules into glucose. The copepod eats the diatom, and its enzyme system breaks the hydrogen bonds in glucose, so that the end products of glucose are carbon dioxide and water, which diffuse back into the water and are available to diffuse into another diatom chloroplast. (By using simple organisms and viewing them microscopically first, students can really begin to understand these major cycles.)

⁴Art

3. PRODUCERS, CONSUMERS, AND DECOMPOSERS ILLUSTRATE ENERGY TRANSFER IN AN ECOSYSTEM; HOWEVER, ENERGY IS NOT RECYCLED.

- Have students study some major examples of producers, consumers, and decomposers. Continue with a discussion of ecological pyramids and discuss the reasons for the limited number of organisms at each level. Have the class make a compost heap near the classroom. Enlist the support of local nurseryworkers or groundskeepers. Have students continually care for the compost and record its temperature periodically. Relate the temperature change to the roles decomposers have in an ecosystem, illustrating that with each step in a food chain much potential energy is lost as heat; therefore, organisms at each succeeding level pass on less energy than they receive.

- Review various feeding levels in a community. Include a discussion of producers, herbivores, carnivores, omnivores, and decomposers. Discuss the number of steps possible in a food chain based on each succeeding level passing on less energy than it receives. Place students in groups and have them compare the amount of energy a person would use if he or she existed as a herbivore, a carnivore, or as an omnivore. Have students relate their data to life in third world countries today.⁴ Finally, have each group synthesize its hypothetical data and predict future eating habits for human populations, placing emphasis on the concept that the number of organisms becomes smaller as energy passes through each successive link of the food chain and that it is only by shortening the food chain that there is enough energy to go around.

⁴History-Social Science

4. THE CAUSE AND EFFECT OF CHANGE IN ECOSYSTEMS THROUGH TIME IS EVIDENCED BOTH IN TERMS OF NATURAL (SUCCESSION) AND HUMAN (CONSERVATION, POLLUTION) INTERVENTION.

- Select a local issue for the year that has some meaning for your class (e.g., closing a desert motorcycle course, banning hunting or fishing in some popular area). Have students keep newspaper accounts of the issue, attend city council meetings, and listen to the comments of local newscasters. Have them record information from old-timers in the community. At the end of the year, have students organize all the data that have been collected and set up a class debate in regard to the long-term consequences of decisions which may or may not be made at the local level.⁴

⁴English-Language Arts

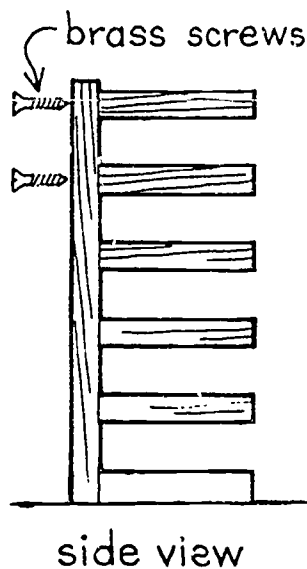

- Ask students whether they or anyone they know has had to clean the bottom of a boat that has been left in the water. (Relate that there is some evidence to support that the number of fouling organisms on the bottom of ships led to the defeat of the Spanish Armada.) Have students cut out 6-in. (15.2-cm) square pieces of pine and attach them to a back panel with brass screws. Suspend this panel from a local dock (Harbor Master docks can often be used). Every two weeks during the year have students remove a block and bring it into class in a bucket of seawater. (This activity can also be done in fresh water.) Have students scrape the block with razor blades and make microscope observations. In the spring, many macroscopic plants and animals will appear. Further information in regard to pH, water depth, current, temperature, turbidity, oxygen, and salinity can be collected and analyzed. Succession will be shown to be a process in which ecosystems change over time. As changes occur in the physical features of the system, new species move in and population sizes change.

EARTH SCIENCE (7-8)

A. ASTRONOMY

1. NUMEROUS KINDS OF ASTRONOMICAL OBJECTS ARE KNOWN TO EXIST WITHIN THE UNIVERSE AND CAN BE CLASSIFIED IN TERMS OF THEIR PROPERTIES.

1-mm

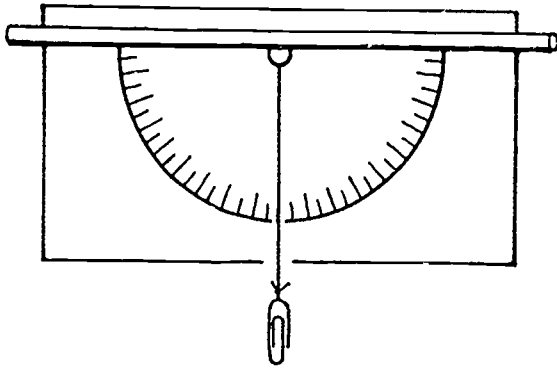

- Discuss the early voyages of Balboa and Cabrillo along the Pacific Coast. Ask students to hypothesize how these explorers determined their position when they were beyond the sight of land. Lead into a discussion of celestial navigation and the instruments which are used, such as sextants. Next have students make homemade transits using protractors and soda straws. Discuss Polaris and circumpolar constellations and ask students to think about where Polaris would be located using their transits if they were at the north pole or the equator. Review the concepts of latitude from geography classes. Have students go home and record their angle observations of Polaris. (If they then subtract their readings from 90° , they will obtain local latitude.)⁴ Continue developing student understanding of space-time relationships by recording and graphing the changing positions of the moon and selected constellations at specific times and locations throughout the year.^{1,2}

¹Kepler

²Planetary Positions/Motion

⁴Mathematics (See page 2 for an explanation of entries like these.)

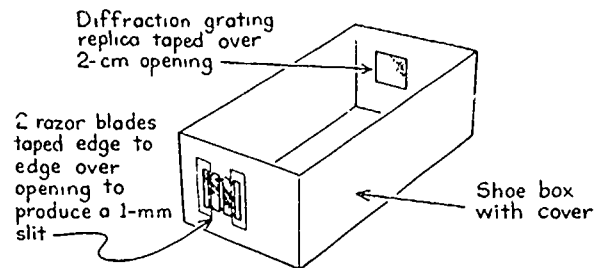

- Review with students that even though many bodies in the universe cannot at present be physically analyzed, there are other means of determining their properties. One such means is an instrument that can "fingerprint" a star by describing the light emitted by the star. Have students make shoe box spectroscopes and compare various light sources: incandescent bulbs, fluorescent tubes, street lamps, colored flames produced by adding various elements and compounds, and light passing through colored filters. Students will observe that a spectroscope can be used to describe bright-line spectra of various elements and can infer that light from stars, when analyzed, provides information about their temperature, size, age, composition, and distance.

2. DISTANCES IN SPACE ARE VAST BUT ARE MEASURABLE.

- Have the students work in groups and estimate the distance to each of the following: the moon, the sun, the nearest planet, the nearest star. Write estimates on the board and introduce the concept of scientific notation. Then ask students to relate their estimates to any distances they do know, as well as to relate the sizes of planetary objects to the sizes of known objects. Continue this discussion periodically for a few weeks prior to Solar System Day. Set up the scale model of the solar system described below in the school yard. Return to class and review scientific notation. Generalize about sizes and distances in space, reviewing that distances to the stars are so great that direct measurement is not

possible; therefore, distances are expressed in light years and in scientific notation.

Body	Distance*	Scale size in millimeters	Suggested model
Sun	-----	232	Yellow balloon, about 25.4 cm
Mercury	9.7	0.8	Head of straight pin
Venus	8.3	2.0	Head of dressmaker's pin
Earth	6.9	2.1	Head of dressmaker's pin
Mars	13.1	1.1	Head of straight pin
Jupiter	91.7	24.0	2.5-cm Styrofoam ball
Saturn	108.1	20.0	1.9-cm Styrofoam ball
Uranus	240.4	8.6	Dried garbanzo (chick pea)
Neptune	271.1	8.2	Dried garbanzo (chick pea)
Pluto	234.0	6.0	Salt grain

Nearest star: 6,667 kilometers from sun.
Moon: a grain of salt 6.4 centimeters from earth.

*Scale in meters from last body.

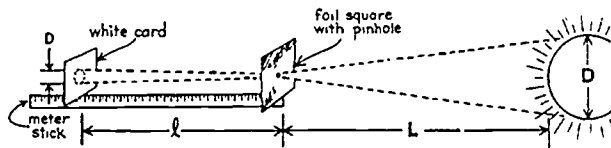

- Place students in groups with various resource books and ask them to devise a way to measure the diameter of the sun. Discuss various hypotheses that are formulated. Review ratios from mathematics (e.g., $1/2 = 4/8$, $3/6 = 2/x$). Give students the ratio $D/L = d/l$ and then assist them in setting up experimental procedures. (Help students to manipulate variables from the equation into the form $D = dL/l$, and solve for D.)⁴ Predict patterns for measurement of solar bodies.

⁴Mathematics

3. THE TILT OF THE EARTH'S AXIS PRODUCES SEASONAL VARIATIONS.

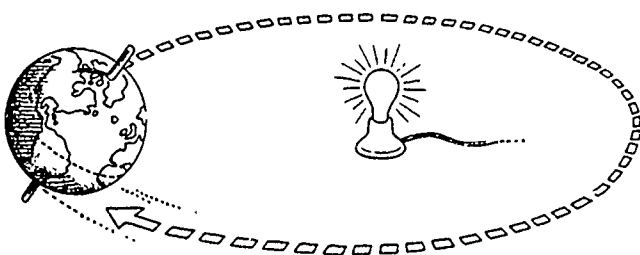

- Have students develop a list of hypotheses to explain the difference between summer and winter. Review the concept that the earth's axis is tilted ($23\frac{1}{2}^\circ$) from the perpendicular to the plane of its orbit about the sun. Winter occurs in the Northern Hemisphere or Southern Hemisphere when this part of the earth is tilted away from the sun, resulting in shorter daylight hours and in a lower angle of incidence of the sun's rays. Set an unshaded light bulb in the center of the room. Walk around the room with a globe, keeping the axis pointing in the same direction. Students will notice directness of rays and varying amounts of radiation striking different parts of the earth.

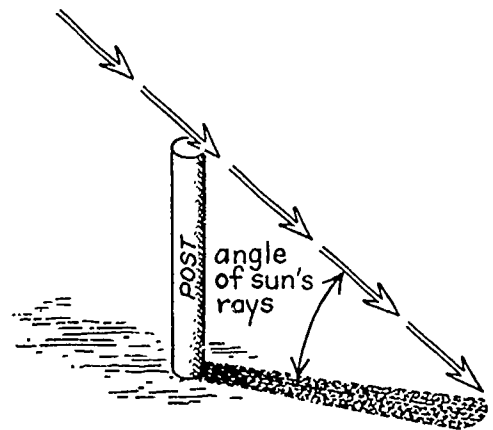

- Lead the students in a discussion of how they could experimentally measure and record different seasons (e.g., counting the number of leaves under certain trees throughout the year, recording the daily temperature, counting insects or birds throughout the year). Suggest to students that they could develop some excellent explanatory models for the seasons by using angles. Since the tilt of the earth's axis produces seasons, set a vertical post in the school yard. Have students record the length and position of the shadow cast by the sun each day at the same time during the entire school year. Also have them record the angle of the sun's rays. Have them transfer this information to graph paper and conclude with research papers analyzing the data.⁴

⁴Mathematics

B. GEOLOGY and NATURAL RESOURCES

1. THE DYNAMIC NATURE OF THE EARTH'S CRUST IS EVIDENCED BY LANDFORMS ARISING BY A VARIETY OF BUILDING UP (FOLDING, FAULTING, VOLCANISM) AND TEARING DOWN (WEATHER AND EROSION) PROCESSES.

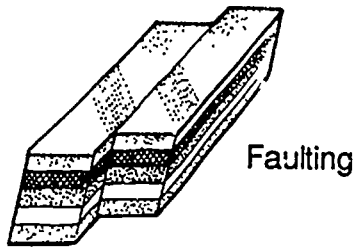

Faulting

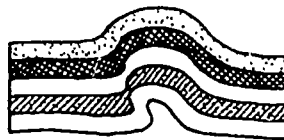

Folding

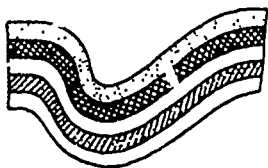
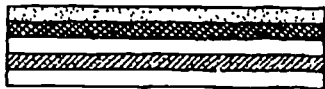

- Use video and books to review the process of folding and faulting. Relate the discussion to local examples when possible (e.g., faulting is illustrated by mountain ranges such as the Grand Tetons, whereas folding is illustrated by the Appalachians). To illustrate faulting, have students paint different colored layers on blocks of wood or Styrofoam. Move the blocks up and down or back and forth to demonstrate thrust and strike slip faults. To illustrate folding, have students glue together alternate layers of different colored foam rubber or felt. Push the stack of foam rubber or felt layers to represent anticlines and synclines.

- Crystal plates are named for continents or major features and represented by models and maps. These maps can be used to recognize and predict patterns of earthquakes and volcanoes. Give students data tables that list latitude and longitude readings for earthquakes and volcanoes that have occurred throughout the world in any one year. Have them plot each of these on crystal plate maps superimposed on world maps.⁴ Have students analyze the relationship between earthquake positions and the shape of continents and analyze the general patterns for the location of volcanoes, knowing that earthquakes generally take place when rocks suddenly snap along fault lines and that the most active volcanoes on land are found mainly in a narrow belt that circles the Pacific Ocean.

⁴Mathematics, Geography

2. THE ROLE OF PLATE TECTONICS IS EXEMPLIFIED IN THE FORMATION OF FEATURES AND PHENOMENA FOUND ON THE EARTH, SUCH AS THE SHAPES AND LOCATIONS OF CONTINENTS, MOUNTAIN RANGES, VOLCANOES, OCEAN TRENCHES, AND EARTHQUAKE BELTS.

- Have students read some of the history of continental drift.² Include information about Sir Francis Bacon¹ and Alfred Wegener. Discuss the unwillingness of scientists to accept early theories and hypotheses and the emphasis placed on land bridges for many years. Have students work in groups and cut out continents from a world map showing physical features of the earth. Ask each group to combine the continents to show their positions as parts of Pangaea. Also ask students to experiment with other ways in which the continents could fit together. Have the groups report to the class on their best fit of continents and give evidence supporting their model.

¹Francis Bacon

²Plate Tectonics

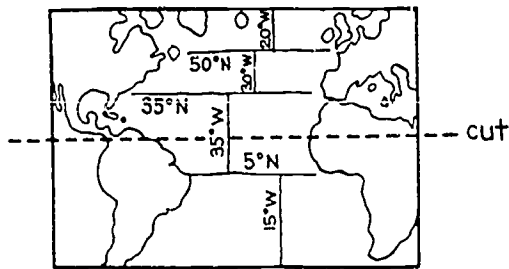

Outline map with Atlantic Ocean cut along indicated parallels

Box with indicated meridians cut

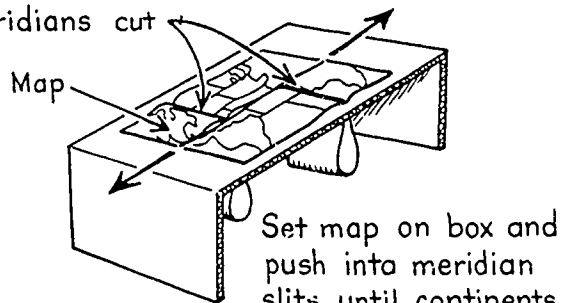

Slowly pull apart to show seafloor spreading and movement along transform faults.

- Engage students in a discussion of major scientific discoveries that have occurred throughout history. Ask them whether they can think of any major discoveries that may have occurred within the past 30 years in the earth sciences. Lead into a discussion of sea-floor spreading. Place students in groups and have them construct the model of sea-floor spreading. Ask them to use their model to theorize what will happen through time in regard to the continents. Follow up by assigning research reading about the work of Maurice Ewing, H. H. Hess, and J. Tuzo Wilson. Students can present this information as a panel discussion.⁴

⁴English-Language Arts

3. SCIENTISTS ESTIMATE THE AGE OF GEOLOGIC FORMATIONS AND ESTABLISH A GEOLOGIC TIME SCALE TO SEQUENCE EVENTS IN THE FORMATION OF THE EARTH.

- Review geologic time scales with students and discuss various geological periods.² Review past discussions about distances in space and the need to relate these data to something known. Explain that just as space-time relations were useful for astronomical understanding, special relational understanding is also needed for past events. Place students in groups and give each group a roll of adding machine tape. Using a scale of 5 mm = one million years, ask students to mark the beginning of each geological period. (The Cambrian period to the present will require about 3 m of paper; beginning with the formation of the earth will require about 23 m!) The completed time scale may be enhanced with cutouts or drawings of life forms typical of each period.⁴

²Geologic Time

⁴Mathematics

- Review information about the age of dinosaurs and some famous dinosaurs. Ask students to theorize about the naming of various dinosaurs. Can they think of some subject they are presently taking that might help them better understand dinosaur terminology, as well as the derivation of other scientific terms? Give students a list of prefixes and suffixes used in naming prehistoric animals. Students can use this list to decipher names of several ancient animals (e.g., stegosaurus). Applying the knowledge gained of known dinosaurs, students should be asked to make up names for make-believe creatures using the prefix-suffix list. Conclude by having each class member draw an original variety, as well as write a description of it. (See list on next page.)

ETYMOLOGY LIST • FOR DESIGNING A DINOSAUR

ALLO	- other	MACRO	- large
ALTO	- high	MICRO	- small
AMMO	- sand	MIMUS	- imitator
ANATO	- duck	MUSSA	- mouse
ARCHEC	- ancient	NANO	- dwarf
ARGYRO	- silver	NODO	- knot
ARISTO	- best	NYCHUS	- claw
ARTHRO	- jointed	OCTO	- eight
AVI	- flight	ODONTO	- teeth
ARO	- heavy	OPS	- face
BRACHIO	- arm	ORNITHO	- bird
CAMPY	- bent	OTHERIUM	- beast
CAUDO	- tail	OVI	- egg
CEPHALO	- head	PACHY	- thick
CERATO	- horn	PALEO	- old
CETIO	- whale	PELORO	- monstrous
CHEIRUS	- hand	PENT?	- five
CHONDRO	- bony	PCR	- sharp
COELO	- hollow	PLATTEO	- flat
COLONO	- hill	PODO	- foot
COMSO	- pretty	POLY	- many
CONICAL	- cone-shaped	POST	- after
CORYTHO	- helmet	PRI	- saw (as in tool)
CRYPTO	- hidden	PRO	- before
CYANO	- blue	PSEUDO	- false
DASPLETO	- frightful	PSITTA	- parrot
DECA	- ten	PTERYX	- leather
DI	- two	RAPTOR	- thief
DINO	- terrible	REX	- king
DOCUS	- beam	RUFUS	- red
DONTO	- teeth	SARCO	- flesh
DROMEIO	- running	SAURUS	- lizard
DORSO	- back	SIGNO	- slow
DERMA	- skin	SINO	- Chinese
ECHINO	- spiny	SPINO	- thorn
ELAPHRO	- light	STEGO	- roof
ERECTO	- upright	STENO	- narrow
FERRIS	- iron	STRUTHIO	- ostrich
ASTR	- stomach	STRYACO	- spiked
GALLI	- low	TETRA	- four
GNATHOS	- jaw	THESCELO	- wonderful
HADRO	- big	TOPHON	- snake
HEPTA	- seven	TORNIO	- savage
ILIO	- crocodile	TORSO	- body
INGENIA	- ingenious	TRI	- three
JAUNDICE	- yellow	TYRANO	- tyrant
LAOP	- woodland	VELO	- swift
LAPHOS	- crest	ZANCL	- sickle

gallon (3.8-L) plastic jugs. Next, have each team use ten 1-gallon (3.8-L) jugs full of water to represent the earth's total water supply. From this total, take out 4.5 cups (1.06 L) to represent the fresh water on the earth's surface. From these 4.5 cups (1.06 L), remove 3.5 cups (0.82 L) to represent what is located in glaciers, ice caps, soil, and the atmosphere. From the remaining 0.23 L (1 cup), take away all but 1 mL (ten drops) to represent water that is too polluted or inaccessible. The remaining 1 mL (ten drops) represents the readily available freshwater supply! Ask students to relate their data to the need for conservation measures. (Also, make certain the water used in this experiment is not put down the drain, but is put to good use.)

- Engage the class in a discussion of conservation issues in relation to business and profit. Have students read *An Enemy of the People*, by Henrik Ibsen.⁴ Discuss the relative importance of the purity of the town's water supply versus the chief economy of the town, realizing that conservation of resources and management of renewable resources are ethical concerns involving individual behavior and public policy.

⁴English-Language Arts

4. CYCLES OF MATTER AND ENERGY ARE RELATED TO RENEWABLE AND NONRENEWABLE RESOURCES AND PROVIDE INFORMATION FOR THE SOCIAL AND ETHICAL IMPLICATIONS OF RESOURCE CONSUMPTION AND CONSERVATION.

- Invite individuals from the Water Quality Board to talk to the class. Also have students watch and report on newscasts of flood and drought conditions around the world. After this, put the following question on the chalkboard: "Of all the water available on the surface of the earth, how much is available for daily consumption?" Place students in groups of five members each and have each member bring in two 1-

C. METEOROLOGY

1. WINDS ARE CAUSED BY THE ACTION OF THE SUN, BY THE EARTH'S ROTATION, AND BY THE EARTH'S SURFACE FEATURES. WINDS INFLUENCE BOTH WEATHER AND CLIMATE.

- Review with students that many mechanical corrections have to be made daily as a result of the earth's rotation. Include a discussion of ships at sea, long-range projectiles, and even throwing a baseball. With chalk or a wipe-off marker, draw a line on a globe from the North Pole to the equator and another line from the South Pole to the equator. These lines represent principal air

movements along the earth's surface if the earth were not rotating. Now draw similar lines while the globe is being rotated from west to east. The resulting lines represent the principal air movement as it is being affected by the earth's rotation (the Coriolis effect). Conclude by having students predict the differences between the movement of global winds in the Northern and Southern Hemispheres.

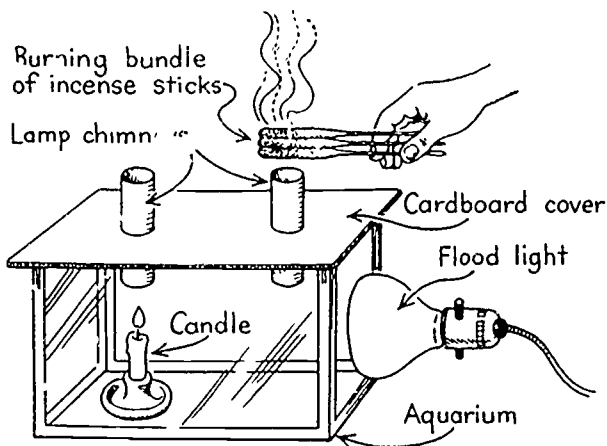

- Ask students how they would ventilate a room if they had no air conditioning. Set up equipment as shown and ask students to write down all their observations—they will be asked to analyze how to ventilate a room properly once the demonstration is concluded. (What will be seen is that hot air over the candle rises and leaves the aquarium. Cold air flows in through the other chimney, taking smoke along with it. Cold air can be seen moving across to the candle, taking the place of the hot air. Wind is caused in a similar way. Shutting off air flow through either chimney will prevent air from moving through the other chimney, also.) This demonstration shows why room ventilation requires a place for hot air to leave and for cold air to enter.

2. SCIENTISTS HAVE DEVELOPED INSTRUMENTS TO MEASURE SUCH WEATHER CONDITIONS AS TEMPERATURE, AIR PRESSURE, RELATIVE HUMIDITY, AND PRECIPITATION.

- Ask a weatherperson from a local radio or television station to report to the class about

the type of equipment that is used for official weather reporting. Follow this by having teams of students procure or make simple equipment to measure temperature, air pressure, relative humidity, and precipitation and use these instruments to monitor and report weather data for the school newspaper. Look for software programs that will allow these data to be stored and analyzed. For students living in rural areas, the temperature data can be used to calculate chill requirements needed for fruit ripening or insect control. (Consult county farm advisor for formulas.)

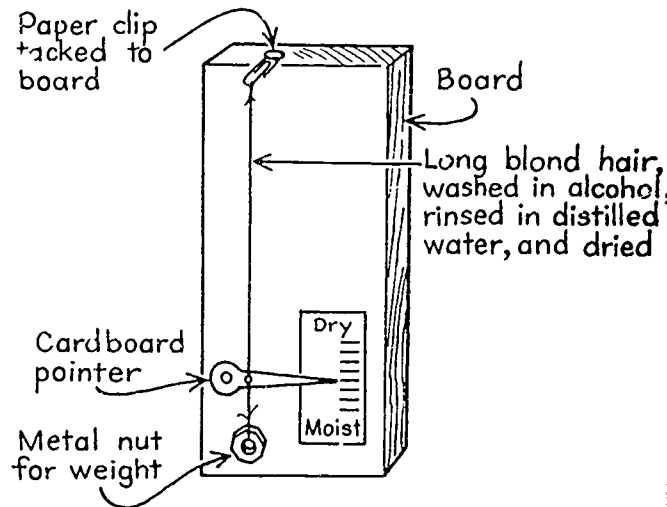
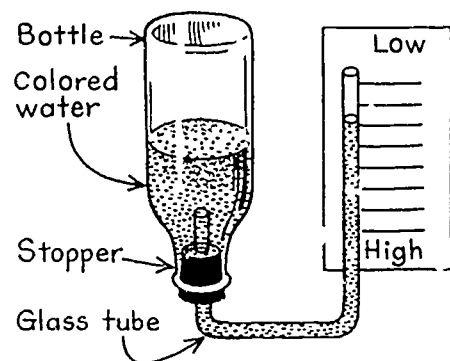

- Discuss the sophistication of weather reporting today. Include weather satellites, computerized analysis, and infrared lasers. Challenge students to see whether they could predict weather as well with simple, homemade equipment. Make a hygrometer to measure relative humidity and a barometer to measure atmospheric pressure. (Keep at constant temperature or use a thermos

bottle to decrease the effect of temperature. Float a drop of oil on the water in the tube to reduce evaporation.) Have students keep records throughout the school year and compare them with published reports.

3. HUMAN ACTIVITIES AS WELL AS NATURAL PHENOMENA AFFECT WEATHER AND CLIMATE CONDITIONS.

- Organize students in groups of two and have them compare and record temperatures above asphalt, concrete, bare soil, grass, ivy, and other ground covers. Have students return to class and record their data on the board. Next, have each student write an analysis of his or her results based on the data accumulated. Finally, discuss the papers in light of the knowledge that substances which absorb or reflect heat influence temperature readings in the immediate vicinity.
- Engage students in a discussion of "clean air." Ask them to research the way air is monitored in communities (e.g., for smog alerts and allergy seasons). Next, have students coat the inside of several petri dishes with petroleum jelly. Set dishes in various locations (e.g., near a factory or shop, near a railroad or an airport, in a home, by a highway). Leave the dishes in place for one or two days and then return them to class and examine them under a microscope to see particulate matter that fell from the air in each location. To quantify the data, you can set the petri dishes on a transparent grid to enable students to count, and later graph, particles per unit of area over time.⁴

⁴Mathematics

D. OCEANOGRAPHY

1. RIVERS AND STREAMS TRANSPORT MINERALS INTO LAKES AND OCEANS, THEREBY CHANGING SALINITY AND AFFECTING LIVING ORGANISMS.

- Ask students whether they know why the ocean is salty? Set up an experiment that will test one of the probable student hypotheses. Have each group fill a small flower pot with garden soil and another pot with garden soil mixed with table salt. Have them run distilled water through each pot and collect leached water in watch glasses or petri dishes. Have them place distilled water in a third glass. (Review with students the significance of a control in experimentation.) Let the water evaporate from each watch glass and check the residue with a microscope or hand lens for salt crystals. Each group can organize its data and write a group paper which relates the experimental data to what happens in nature.
- If possible, take students on a field trip to tide pools or to a local lake, pond, stream, or river. While there, have them collect water samples from different locations. They should include water that has stood in high spray pools as well as deeper water. When students return to class, have them test each sample by placing a measured amount of water in an evaporating dish. Set a watch glass on an evaporating dish. Heat gently until all water has evaporated. (SAFETY: Wear safety goggles.) Have students weigh residual solids, or do a microscopic analysis, to determine the percent of dissolved solids in each water sample.⁴ Engage the class in a panel discussion in which they apply the knowledge they obtained to an analysis of the effects of salinity changes on living organisms. (Refer to Biological Sciences, Cells.)

⁴Mathematics

2. THE FACTORS RESPONSIBLE FOR THE FORMATION OF TIDES, WAVES, AND CURRENTS AS WELL AS THE EFFECTS OF THESE PHENOMENA ON LANDFORMS CAN BE DELINEATED.

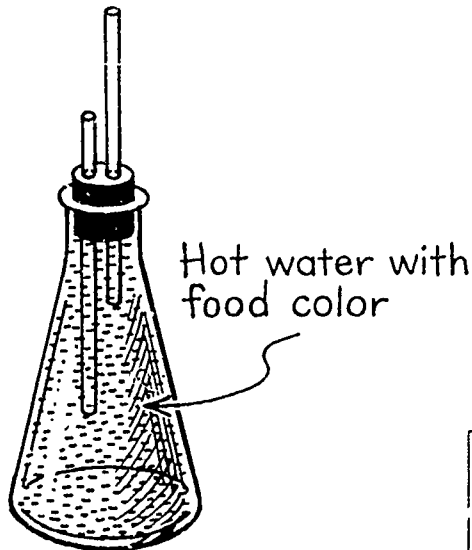

- Review with students some of the major ocean currents in the world, such as the Gulf Stream and the Kuroshio Current. (Include currents off the California coast such as the California Current.)¹ Also review convection currents as they apply to weather changes. Demonstrate to students how convection currents are formed in the ocean. Heat some water containing food coloring, almost to boiling. Pour it into a flask until full. Carefully insert a double stopper with glass tubing. Set the flask in an aquarium full of cold water. Hot, colored water will rise to the surface, while cold, clear water enters the flask. Ask students to write an explanation of what they observed as well as a statement of why the experiment worked the way it did. (Variations in temperature and salinity cause differences in the density of seawater. The density changes, in turn, cause currents.)

¹Humboldt

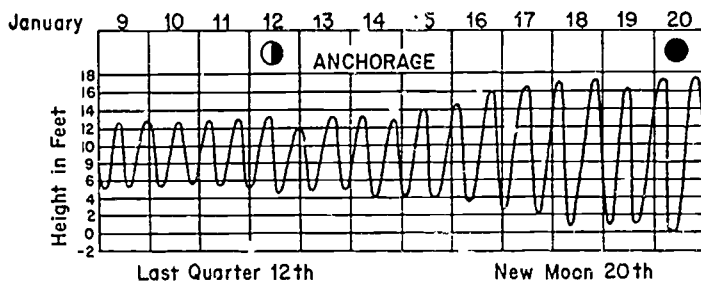

- Ask students to record the moon's position and relative size every night at the same time for one month. Next, have them obtain from a bait shop or diving shop a local tide table. Have them select specific months throughout the year and graph the daily tide cycle for one month at that location. Place each of the moon phases on the graph, and have students compare moon phases to tidal height, showing that ocean tides result from gravitational attractions of the sun and moon.

3. OCEANS AND FRESHWATER BODIES ARE POTENTIAL SOURCES OF ENERGY AND MATERIALS FOR TECHNOLOGICAL APPLICATIONS.

- Split the class into two groups and assign a library project in which one group researches all it can about hydroelectric power plants and the other group researches nuclear power plants. Engage the whole class in a discussion of the environmental impact of hydroelectric and nuclear power plants. Examine factors such as thermal pollution, movement of soil, flooding, disease, and water quality. (Students might want to look at the effects of the Aswan Dam on the Nile or the long-term effects of the disaster at Chernobyl.)⁴

⁴Social Science

- Discuss with students the fact that some coastal cities in France are capitalizing on the regularity and power of low tidal waves or tidal bores moving up narrow bays. The energy from the tidal bores is being harnessed by dams to produce electricity. This technique is now being studied for use in California. Have students research the use of tidal power in terms of providing an inexpensive energy source for industry. Ask them to build a theoretical model of such a plant designed for operation at a specific point along the California coast. Students will make a presentation to the class of their model, and other class members will critique it in terms of energy

efficiency, cost of operation, experimental design, and marketing strategy.

4. MANY SOURCES OF POLLUTION EXIST FOR MARINE AND FRESHWATER HABITATS, AND EACH HAS SUBSEQUENT IMPLICATIONS FOR THE QUALITY OF HUMAN LIFE.

- Determine a major aquatic issue in the local area (e.g., drilling for oil in the Santa Barbara Channel). Have students read the local newspapers, watch newscasts, and interview local citizens in regard to the topic. Randomly sort the class into petroleum engineers and aquatic biologists. Initiate a panel discussion to focus on various aspects of the issue.
- Obtain data from the local health district or sanitation district in regard to the changing bacterial counts in local bays, estuaries, lakes, or rivers throughout the year. Have students graph the population changes and analyze these in relation to season, building activity, decomposition of agricultural pesticides, and other factors.⁴

⁴Mathematics

PHYSICAL SCIENCE (7-8)

A. MATTER

1. THE BASIC PROPERTIES OF MATTER INCLUDE MASS, WEIGHT, VOLUME, AND DENSITY.

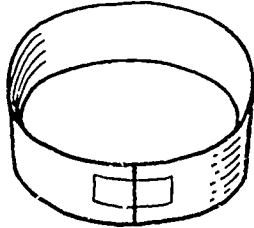

- Ask students whether they can think of examples of craft that are lighter than air. Tell them that the following demonstration will illustrate some properties of air (occupies space and has weight) and will help them hypothesize about lighter-than-air craft. Bend a ring of cardboard and set it on a balance. Next place a deflated volleyball (or basketball, etc.) on the ring. Weigh the deflated ball, and then inflate and weigh again. Follow with a discussion of the properties of various gases and an analysis of the gases of which air is composed. Conclude with gases lighter than air.

- Ask students which weighs more, a pound of feathers, a pound of Styrofoam, or a pound of lead. Discuss with students that the answer to this question is related to a study of density (the ratio of mass to the volume of matter). Have students work in groups and weigh an assortment of objects, measure the volumes by water displacement, and calculate the densities:^{1,2}

- Measure objects of equal volume but different masses.
- Measure objects of equal masses but different volumes. (Use small bottles or vials weighted with sand.)
- Weigh equal volumes of various liquids (water, alcohol, salau oil, glycerine, salt water, etc.) and calculate the density of each.⁴ Be certain to emphasize the standard of density as 1.00 g/cm^3 for water. Ask students to organize and synthesize

their data and write a group generalization supported by their research data.

¹Archimedes

²Buoyancy

⁴Mathematics

2. MATTER IS COMPOSED OF PARTICLES IN CONSTANT MOTION. CHANGES OF STATE IN MATTER RESULT FROM CHANGES IN THE MOTION OF PARTICLES.

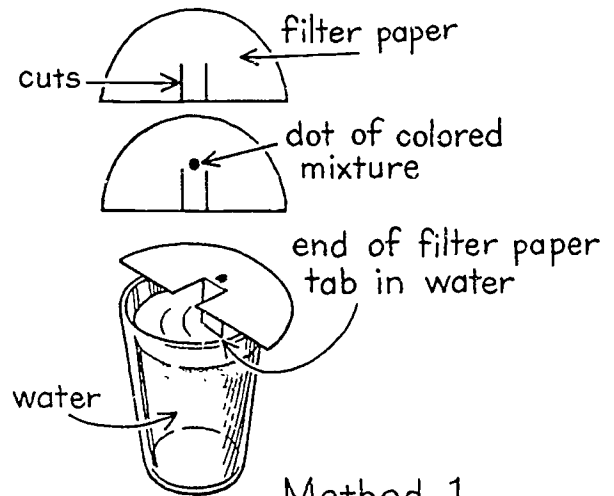

Method 1

bent pin "hook" in bottle cap

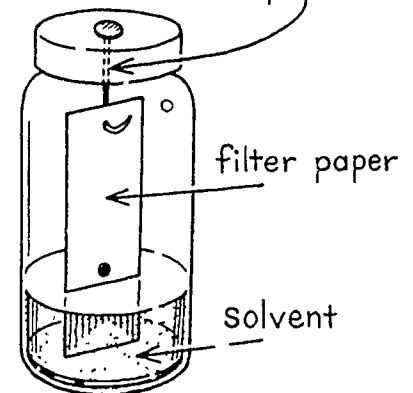

Method 2

- Aristotle challenged Democritus's atom theory by stating that if air were made of atoms, those atoms would not rise but would all "pile up" on the ground. Ask students why was he wrong. (Atoms in motion.) Tell students t. at the following exper-

iment will illustrate this theory: Place a dot of colored mixture (food color, ink, etc.) on filter paper. Put the end of the filter paper in water or another solvent. As the solvent reaches the dot, molecules of various substances in the colored mixture will move across the paper at various rates, producing colored bands.

- Prior to the classroom demonstration, ask students to perform the following experiment at home: Fill an empty ice cube tray with water and place it in a freezer. After the water freezes remove the tray, let the ice melt, and taste the product. Set up the illustrated demonstration. (SAFETY: Make certain there is adequate ventilation for moth balls.) Following the demonstration, have students write up their observations, with attention to the controlling of variables and recognizing and predicting patterns.

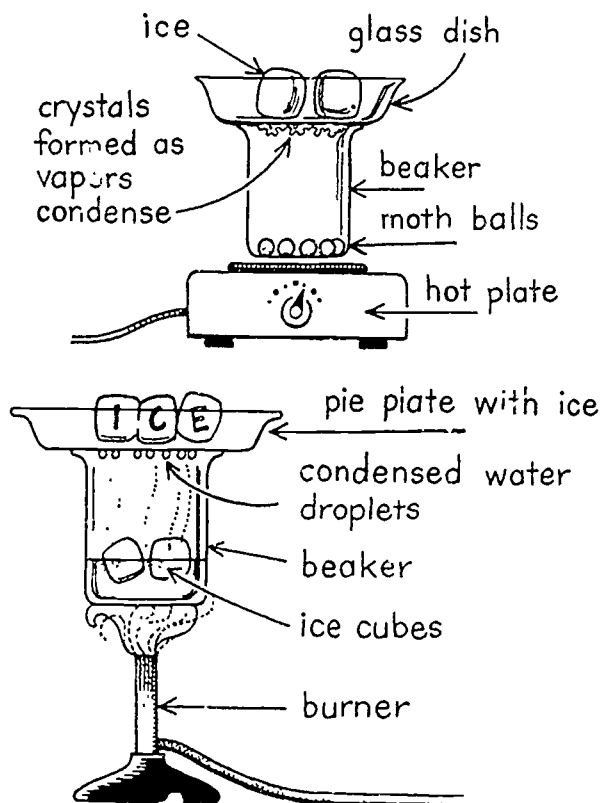

3. IN GASES, THE PROPERTIES OF PRESSURE, TEMPERATURE, AND VOLUME ARE INTERRELATED SO THAT CHANGES IN ONE PROPERTY CAUSE CHANGES IN ANOTHER.

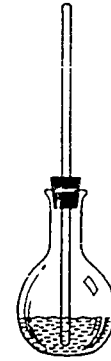

- Have students observe while the instructor boils a small amount of water in an old 1-gallon (3.8-L) can (ditto fluid can, for example). Remove the can from the heat source and quickly cap it. Set the can aside and solicit student hypotheses as to why (after a few minutes) the can begins to buckle and collapse.² Next, place students in groups and tell them they are going to carry on an experiment that will help them understand the ditto can phenomenon. Hand each group a flask, as shown above, which contains water with food color. Ask students to heat the air in the flask with their hands. Molecules move faster and farther apart, increasing pressure on the liquid inside the flask, thereby causing the liquid to move up the tube. Have students place an ice bag on the flask to reverse the process. Conclude with a thorough discussion of the ditto can and the flask.²

²Boyle's Law

- Discuss with students why pressure is felt on the ears when a car door is closed with the windows up. Place students in groups and supply each group with an air piston (plastic syringe) and some bricks. After each brick is added, ask students to record the new volume of the trapped air. After sufficient data have been collected (up to ten bricks), have students graph the total pressure of the bricks versus the volume of the air in the piston.⁴ Conclude by asking students to relate their experimental data to theoretical data that show the volume of air decreases as the pressure increases.

⁴Mathematics

4. THE NATURE OF CHEMICAL ELEMENTS AND THE PROPERTIES OF THE ATOMS COMPOSING THE ELEMENTS CAN BE ILLUSTRATED BY USE OF THE PERIODIC TABLE.

- Make a collection of as many elements as students can obtain. Next, discuss compounds and have students bring in representative samples of various compounds. Place a large periodic table² on the wall and continue a discussion of elements and compounds based on representative samples. Arrange students into groups and have them organize the first 20 elements of the periodic table into some logical sequence other than the use of atomic numbers. Have students present their results to the rest of the class for analysis. (This would be a good opportunity for discussion of whether elements might or might not be able to combine under a different arrangement.) Conclude with students reading about Mendeleev¹ and why he organized the periodic table as he did.

¹Mendeleev, Bohr

²Periodic Table

- After a review of elements, introduce students to scientific theories about the atom. Discuss the structure of the atom and have students read and report on the periodic table. Each student is given a blank periodic table, along with small cards, each bearing the atomic number and mass number of an element. Students attempt to correctly place the element cards on the blank periodic table. (Students look for common characteristics of families.) This activity can be made more enjoyable and competitive if it is conducted as a game of bingo. Element cards are drawn at random, and the first student to complete a family or a period wins. The relationship which exists between the atomic masses and the properties of elements is illustrated by the periodic table.

5. ATOMS OF DIFFERENT ELEMENTS COMBINE IN SPECIFIC RATIOS TO FORM MOLECULES, AS ILLUSTRATED BY THE FORMULAS FOR COMPOUNDS. ATOMS ALSO COMBINE IN SPECIFIC GEOMETRIC ARRANGEMENTS TO FORM COMPOUNDS BY MEANS OF IONIC AND COVALENT BONDING.

- Have students observe and compare common substances that are representative examples of the two kinds of bonding. Give each group 2 cm³ of table salt and 2 cm³ of table sugar. Have each group write a paper which emphasizes the comparison between the two compounds in terms of roughness, grain shape, "crushability," and melting point.⁴ Follow with a discussion of covalent and ionic bonding. Have students predict which compound exhibits ionic bonding and which exhibits covalent bonding.

⁴English-Language Arts

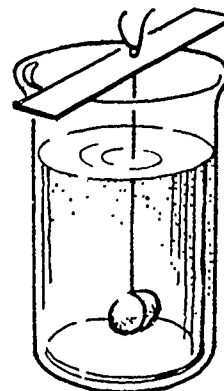

- Hand out recipes for making rock candy and lollipops at home. Ask students to bring products to class. Discuss the process with the class. Lead into a discussion of crystals and their geometric arrangements and formation. Ask students to keep careful notes of their observations, make accurate drawings, and be ready to recognize and predict patterns for these laboratory activities.
 - a. Dissolve as much solid as possible in a small jar of boiling water. Suspend a weighted string in the solution. Borax will form crystals on cooling. Alum,

copper sulfate, and magnesium sulfate work well.

- b. Spread a drop or two of saturated solution on a microscope slide. Heat gently over an alcohol lamp and observe crystals forming under the microscope.
- c. Place a clean copper wire on a microscope slide. Add two drops of dilute silver nitrate solution. Observe crystals forming under the microscope.

6. CONSERVATION OF MASS IS ILLUSTRATED BY CHEMICAL EQUATIONS WHICH DESCRIBE THE REARRANGEMENT OF ATOMS INTO DIFFERENT SUBSTANCES. SINGLE REPLACEMENT, DOUBLE REPLACEMENT, SYNTHESIS, AND DECOMPOSITION ARE EXAMPLES OF THESE REACTIONS.

- Ask students to give examples of various chemical reactions observed in nature. Keep a list posted for the year and have students continually add to it. (Examples include rusting cars, baking bread, souring milk, and tarnishing silver.) Have students continually review the difference between physical reactions and chemical reactions as the list grows.
- Discuss with students the common reactions occurring in nature that illustrate various types of chemical reactions:

- a. Synthesis—silver in a spoon reacting with sulfur in the air to tarnish
- b. Decomposition—milk breaking down into simpler sugars and other chemicals when it sours
- c. Single replacement—in smelting iron, carbon taking the place of the iron in the ore
- d. Double replacement—many paints in which lead and potassium compounds exchange elements

After this introduction, have students work in groups and carry out a variety of experiments to illustrate the above reactions. (SAFETY: Wear goggles and work very carefully.)

a. Synthesis: $2\text{Mg} + \text{O}_2 \rightarrow 2\text{MgO}$
(SAFETY: Burn a magnesium ribbon in a well-ventilated room. Do not stare at burning Mg.)

b. Decomposition: $2\text{NaHCO}_3 \rightarrow \text{Na}_2\text{CO}_3 + \text{H}_2\text{O} + \text{CO}_2$
Heat baking soda in a test tube fitted with a delivery tube. Collect CO_2 in a loosely covered beaker. Notice H_2O condensing in the upper part of the test tube.

c. Single replacement: $\text{Fe} + \text{CuSO}_4 \rightarrow \text{Cu} + \text{FeSO}_4$
Immerse a clean, shiny iron nail in CuSO_4 solution. Copper will plate on the nail.

d. Double replacement: $\text{CuSO}_4 + \text{Na}_2\text{CO}_3 \rightarrow \text{CuCO}_3 + \text{Na}_2\text{SO}_4$
A precipitate of copper carbonate will form.

Have students write up the results of their experiments with an emphasis on being able to generalize from their specific data.

7. THE STUDY OF RADIOACTIVITY AND NUCLEAR FISSION AND FUSION REACTIONS NECESSITATES AN UNDERSTANDING OF THE TECHNOLOGICAL APPLICATIONS AND SOCIAL IMPLICATIONS INVOLVED.

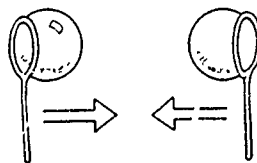
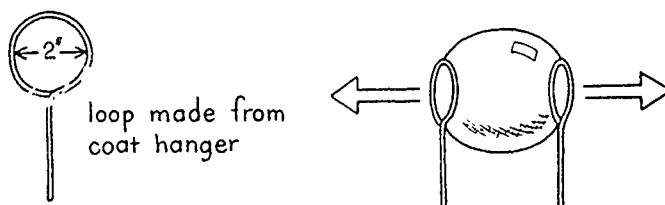

- Have students read about fission and fusion.¹ Discuss nuclear power plants, nuclear submarines, and spacecraft travel to distant planets as illustrative of fission reactions. Review the reactions that occur inside the sun and other stars as fusion reactions. To demonstrate to the class these two types of reactions, make two wire loops (2 in. [5.1 cm] in diameter) and dip them into a soap solution. First, blow a soap bubble (approximately 4 in. [10.2 cm] in diameter) and trap it between the two wire loops. Slowly pull the loops apart to form two smaller bubbles, one on each loop, to represent a fissioning nucleus. Second, blow two similar bubbles and hold one on each loop. Carefully press the two bubbles together to form one larger bubble, representing the fusing of two nuclei. Conclude by asking students to draw pictures of fission and fusion reactions.⁴

¹Marie Curie, Oppenheimer

⁴Art

- After a thorough review of nuclear reactions, have students use current journals and newspapers to analyze the nuclear power industry. Ask them to keep cards on file of all their information. Conclude by having groups write papers theorizing about the future of the nuclear power industry in California based on the data they have collected.

B. MECHANICS

1. ENERGY, FORCE, PRESSURE, WORK, AND POWER ARE RELATED. SIMPLE AND COMPLEX MACHINES EXEMPLIFY THE USE OF ENERGY TO DO WORK.

- Ask students whether they think they are often misled by their senses. Pass around the room a vial of lead shot and a large block of Styrofoam of equal weight. Have students write down which one they think is heavier and why. Next, place students in groups and give each group a similar vial of lead shot and a similar large block of

Styrofoam of equal weight. After students have discussed their prior hypotheses with one another, have them weigh each object and discuss their findings. (The vial of lead shot will feel decidedly heavier. Although both objects exert the same downward force on the hands because of gravity pulling on equal masses, the pressure of the vial of shot is greater because its force is concentrated on a smaller area.)

- Explain to students that during the early days of airline service, women were not allowed to wear high heels on board planes. Ask students to theorize why this might be true since thousands of pounds of materials were loaded into these same planes. Explain that the following experiment will help to give the answer, but each group will have to first bring a spike heel to school the next day.
 - a. Calculate the area of the spike heel.
 - b. Weigh the person who wears the heel.
 - c. Calculate the pressure per square inch on a heel if the person places her entire weight on one heel. (This explains why heels puncture floors and punctured early passenger airplane aisles.)
 - d. Repeat calculations for a flat sole shoe with the realization that pressure is the force per unit of area on which the force acts.⁴

⁴Mathematics

C. ENERGY: SOURCES OF TRANSFORMATIONS

1. POTENTIAL AND KINETIC ENERGY EXIST IN MANY FORMS (E.G., MECHANICAL, HEAT, LIGHT, SOUND, ELECTRICAL, AND MAGNETIC).

- Discuss with students various roller coaster rides they may have taken. Review the rides in terms of the potential and the kinetic energy of the cars. Ask students to hypothesize why each hill in the ride is a little less high than the one before it. (Some energy is lost in overcoming friction.)

tion.) Tell students they will apply some of the ideas from the discussion to some simple "machines" in the classroom. Examine a variety of spring wind-up toys and discuss the potential and kinetic energy relationships that exist. Extend the discussion to battery-operated toys. Finally, have students construct rubber band wind-up toys (e.g., balsa wood airplanes with rubber band-powered propellers). Ask them to use their models to explain to the class potential and kinetic energy concepts.¹ (Potential energy is stored energy that can be released to do work. Kinetic energy is energy in the form of motion of an object.)

¹Newton

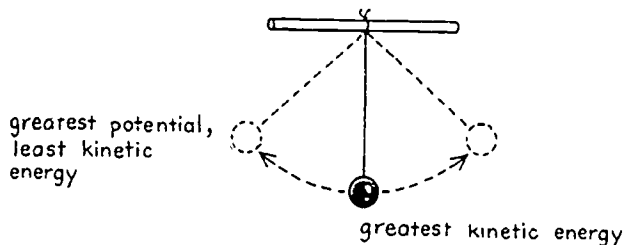

- After reviewing concepts of kinetic and potential energy and giving examples of devices that illustrate conversions between potential and kinetic energy (e.g., clocks and pendulums), introduce the formula for determining the amount of kinetic energy present: $KE = \frac{1}{2}mv^2$ (where $v = d + t$). Give each group of students a pendulum and structure the lesson as a laboratory research day where students are given a problem and they apply their prior knowledge to solve the problem. Experiments are to be conducted and data recorded, graphed, and analyzed.⁴ The problem: Using a pendulum, determine the points where kinetic or potential energy is the greatest and the least.

⁴Mathematics

D. ENERGY: HEAT

1. HEAT, TEMPERATURE, AND HEAT CAPACITY ARE RELATED. HEAT MAY BE TRANSFERRED BY CONDUCTION, CONVECTION, AND RADIATION.

- Place students in groups and give each group a series of equal sized squares of different materials (metal, linoleum, smooth cardboard, glass, carpet, etc.). Have each group make a chart and record the apparent temperature reactions of group members as they place their hands flat on each material. Bring the class together and record the data for each group on the board. Define conduction and give examples of good conductors (metals such as aluminum and copper). Continue with a discussion of insulators and examples of good insulators (non-metals such as wood and plastic). Finally, ask students to look at their experimental data and hypothesize why there appeared to be differences in apparent temperature. (All materials are the same temperature, but the metal feels cold and the carpet feels warm because the metal conducts heat away from the hand rapidly, whereas the carpet does not.)

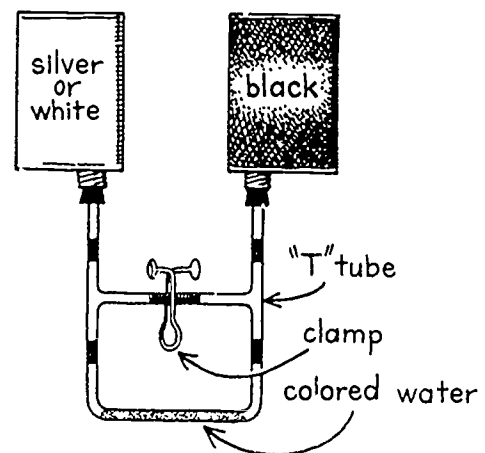

- After a discussion of conduction, convection, and radiation, review with students careful laboratory technique prior to assigning the following experiment. Have students set up the equipment as shown

above. Shine a 100-watt light evenly on both cans. Expanding air pushes colored water to one side. Turn off the light and release the clamp to equalize the pressure. Replace the clamp. As the cans cool, colored water moves to one side. (Radiant heat [infrared radiation] from a lamp is absorbed by a black surface more readily than a light surface. Consequently, the air in the black can is heated more and, therefore, expands more.) After students have completed the experiment, have them work in groups and design a similar experiment that will give them quantifiable results. Have groups present their experiments for the class as demonstrations.

2. TEMPERATURE IS A MEASURE OF MOLECULAR MOTION. BOTH SIMILARITIES AND DIFFERENCES EXIST AMONG FAHRENHEIT, CELSIUS, AND KELVIN TEMPERATURE SCALES.

- Ask students to guess what the air temperature is in °F, °C, and °K. Ask them to write their answers on a piece of paper; collect these and put the answers on the board. Discuss the three scales and how they are used. Explain to students that they will use Celsius readings continually in science classes and that many scientists also use the Kelvin scale.¹ (Since Kelvin thermometers are not readily available, show students how to use ratios to determine °K. A calculator is especially useful at this time.) Place students in groups and have them measure the temperature of hot water every two minutes as it cools from boiling. Both Fahrenheit and Celsius thermometers are used and Kelvin units are determined mathematically. The resulting temperature versus time data are then graphed using a different color for each temperature scale.⁴

¹Kelvin

⁴Mathematics

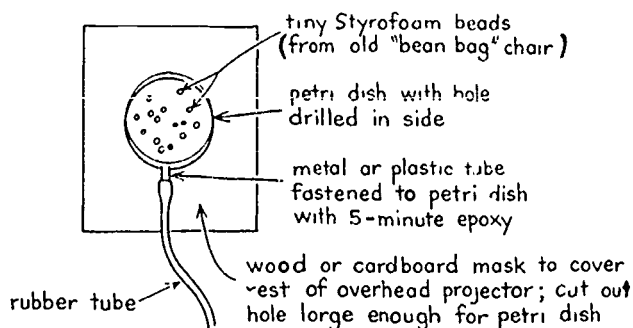

- This activity is a demonstration for students so they can more easily conceptualize molecular motion during temperature change. Set up equipment on an overhead projector as shown above. Blow into the hose to set "molecules" in motion. Blow hard to represent high temperature, gently to represent low temperature. Add more beads ("molecules") to represent a great amount of heat, even if the speed of particles (temperature) remains constant.

E. ENERGY: LIGHT

1. LIGHT CAN BE DESCRIBED IN TERMS OF BOTH THE WAVE AND PARTICLE THEORIES, WITH LIGHT ENERGY PROPORTIONAL TO FREQUENCY AND WAVELENGTH.

- Have students each take a file card and make a small pinhole in the card. Have them look at a light in the distance. Use their observations to lead into a discussion of the wave and particle theories of light. Explain that some experiments show light is made up of waves, whereas others show that light is a stream of small particles. After preliminary discussion, have students break into groups and give each group a stopwatch to time their pulse rates. Then have them record data from the following activity:
 - Have students travel a distance of 3 m in 5 seconds, hopping five times. Have them record pulse rates for 15 seconds.
 - Have students again travel 3 m in 5 seconds, hopping ten times. Have them record their pulse rates for 15 seconds.

- c. Compare the number of hops required to travel the distance in a given time as the length of hops is longer or shorter.
- d. Notice which requires more energy—a few long hops or many short hops?
- e. Draw the analogy between the hopping students and the wavelength, frequency, and energy of photons.

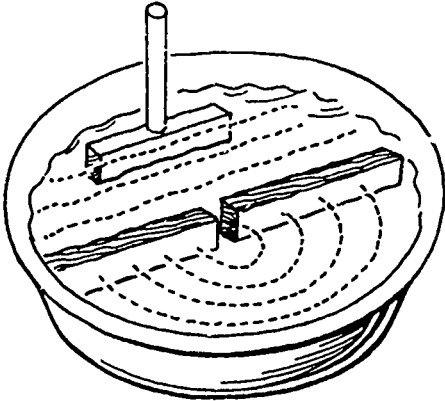

- Discuss the old argument between proponents of the wave and particle theories of light.¹ Fill a shallow circular tray with about 1 in. (2.5 cm) of water. Fasten across the tray a barrier that has a small opening. Move a small block of wood rapidly up and down at the end of the tray and observe the behavior of the waves as they pass through the tray. Students can sketch wave patterns and relate these to the behavior of the particles that pass through the hole in the barrier. Only particles passing directly through the slit will continue on the other side of the barrier; waves passing through will propagate outward from the slit.

¹Huygens

1. LENSES, MIRRORS, AND PRISMS CAN BE USED TO REFLECT AND REFRACT LIGHT, AND THEY ALSO HAVE A WIDE VARIETY OF TECHNOLOGICAL APPLICATIONS.

- Discuss with students how images appear inverted when viewed through a convex lens. Print the words "OXIDE" and "JAGUAR" in block letters on an index card. Have students lay an empty test tube

over the letters and slowly raise the test tube while viewing the words through it. Fill the test tube with water and cap it with a rubber stopper. Have them repeat, viewing the words through a water-filled test tube. (The water-filled test tube, acting as a convex lens, bends light rays sufficiently to invert the image. "OXIDE" appears erect because the letters appear the same inverted.)

- Discuss with students how the angle at which light strikes a mirror compares with the angle at which it bounces off. Place a hinged mirror behind a coin on a sheet of paper. Arrange the angle of the mirrors so that three equally spaced coins can be seen. Trace the angle of the mirrors and measure the angle with a protractor. Multiply the number of coins by the angle. Repeat for four, five, and six coins, remembering that the angle of incidence equals the angle of reflection.⁴

⁴Mathematics

F. ENERGY: ELECTRICITY and MAGNETISM

1. ELECTRICITY AND MAGNETISM ARE RELATED. THERE ARE DIFFERENCES IN THE PRODUCTION AND EFFECTS OF STATIC AND CURRENT ELECTRICITY.

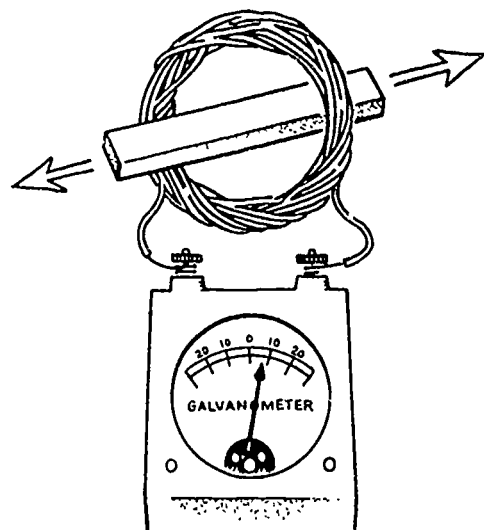

- Have lengths of insulated wire and bar magnets set out for students. Ask whether they can devise a way to use these materials to create sufficient electric current to be measured by a galvanometer.¹ Students hypothesize and try various ways of arranging and moving the wire and magnets relative to each other. Straight lengths of wire and student-wound coils of various lengths should be used. Have them try to move either the coil or the magnet. Students then organize their data and report on the effect of the number of coils of wire, as well as on the relative motion of the coils and magnets.

¹Ampere, Faraday

2. VARIOUS METHODS AND INSTRUMENTS ARE USED IN MEASURING ELECTRICAL POTENTIAL, CURRENT, AND RESISTANCE.

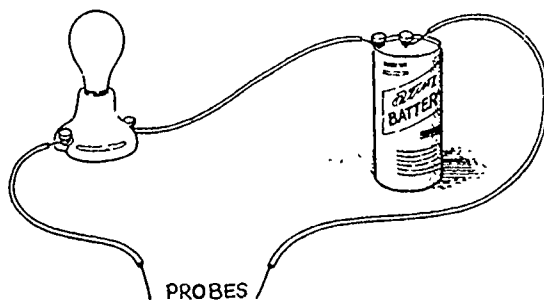

- Discuss with students the phenomena of various conditions impeding the flow of electrons in a circuit (type of conductor, distance, etc.). Place probes in solutions of sugar and distilled water and in salt and distilled water. Try placing probes on a coil and moving one probe along the coil. Also try with a carbon rod. Observe the brightness of the light. Electrical resistance varies, depending on the material the electrons are moving through and the distance they have to travel.

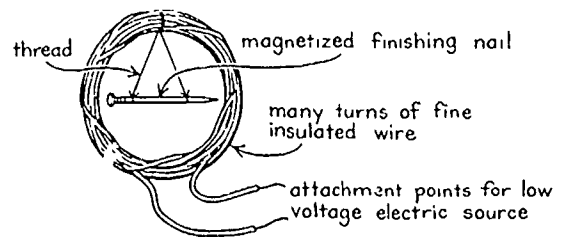

- Show students a variety of electrical meters and attach each to a source of current to deflect the needles. Ask students what makes the needle move. Make a finishing nail galvanometer and attach the apparatus to a low voltage source. Have students observe movement of the magnetized nail. Vary the number of wire loops or vary the current to deflect the nail. (The number of wire loops or amount of current flowing through the wire loops creates a variable magnetic field which will deflect a needle or a meter.)

3. TECHNOLOGICAL AND HOUSEHOLD APPLICATIONS OF ELECTRICITY ARE NUMEROUS.

- Ask students whether they have seen a string of Christmas lights with one bulb removed or burned out, and the remaining bulbs go out. Wire bulbs in a series circuit and then a parallel circuit. Let students compare brightness and see what happens if one bulb burns out or is removed in either circuit. Measure the electrical potential current and resistance at various points along each circuit. The patterns of wiring light-bulbs illustrate complete and open circuits.
- Show students an electrical distribution panel near the classroom and ask them whether they know what the parts are. Suggest that they may need to add a circuit or wire a receptacle or switch in their houses some day. Acquire a single-phase circuit breaker box and wire a 120-volt single-phase circuit. Wire a receptacle to the wires coming from the box. Add a

single-pole switch to the circuit. Tell students to go home and teach someone else what they have learned!

G. ENERGY: SOUND

1. THE WAVE NATURE OF SOUND (COMPRESSION, REFRACTION) AFFECTS PITCH, LOUDNESS, REFLECTION, AND REFRACTION.

- Discuss with students what makes some sounds louder than others. Why does music from the school dance make walls and other objects vibrate? Have students stretch and fasten a piece of balloon over one end of a soup can that has had the top and bottom removed. Put some grains of rice on the rubber covering of the can and place the open end of the can over a radio speaker. The rice will jump up and down according to the volume of the music. Students can "see" that the loudness of a sound is determined by the amplitude of a wave.

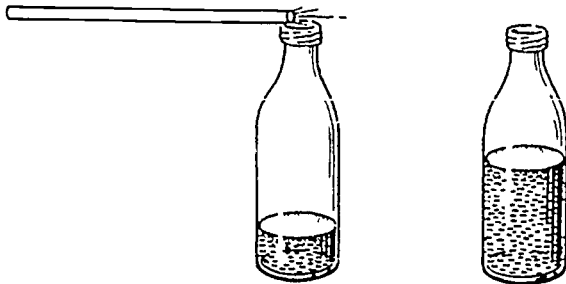

- Discuss with students how the size of a musical instrument relates to the "pitches" of the sounds it produces (e.g., saxophone versus trumpet, or piccolo versus flute). Have students use straws and bottles to blow across the mouths of two identical bottles filled with different amounts of water, noting the differences in pitch. Now strike each bottle with a spoon and have the students note which one has the higher or lower pitch. Other factors being equal, the greater the mass of a body, the lower the pitch.

APPENDIXES

- I. BIOGRAPHIES OF SCIENTISTS
- II. SCIENTIFIC DISCOVERIES
- III. SCIENTIFIC LITERATURE
- IV. SCIENCE MATERIALS

These appendixes to the *Science Model Curriculum Guide* (K-8) are intended to be illustrative of the biographies, discoveries, literature, and materials that teachers could use in generating and maintaining students' interest in science. Throughout the guide are representative learning activities that incorporate selections from these lists. While these are created solely as suggestions, the authors welcome suggestions for additions to and deletions from the list.

APPENDIX I: BIOGRAPHIES OF SCIENTISTS (That Elementary Students Should Study)

Agassiz, Jean Louis

1807—1873

Agassiz, a Swiss-American naturalist and geologist, was best known for showing that the Ice Age had periods of both forward- and backward-moving ice and that glaciers move faster in the center than on the outer edges. As a biologist, he found in his studies of animals that he agreed with Darwin's ideas of evolution, although he did not publicly support Darwin.

Agricola, Georgius

1494—1555

Known as the Father of Mineralogy, the German doctor Agricola tried to bring order into the knowledge of minerals through observation. His most important book, *De Re Metallica*, was translated by Mr. and Mrs. Herbert Hoover, who believed that Agricola was the originator of the experimental approach in scientific study.

Alvarez, Luis W.

1911—

An American physicist, this 1968 Nobel Prize winner studied short-lived subatomic particles found in the nucleus of the atom. Alvarez developed ways of using these particles to investigate events in ancient history, such as the extinction of the dinosaurs and the construction of the Egyptian pyramids.

Ampere, Andre Marie

1775—1836

Ampere, a French physicist best known for his studies in electric currents and related magnetic forces, gives name to the unit of intensity of an electric current. Early in his career, Ampere suffered from depression caused by the execution of his father and the early death of his wife.

Archimedes

287 B.C.—212 B.C.

A great scientist of ancient Greece, the mathematician Archimedes is best known for his

explanation of buoyancy and the laws of the lever and pulley. He once said, "Give me a place to stand on and I can move the world." The statement was challenged by King Hieron. Archimedes answered by pulling a loaded ship from the harbor to the shore with a series of pulleys.

Aristotle

384 B.C.—322 B.C.

Aristotle, one of the greatest of the ancient Greek philosophers, developed the idea of deductive logic and is noted for his precise observations of and classifications of living things. About one-third of his writings still survive today and cover topics such as politics, history, ethics, and science.

Arrhenius, Svante August

1859—1927

The Swedish chemist Arrhenius developed the idea of ionic dissociation, for which he was awarded the Nobel Prize in chemistry in 1903. His unbelieving teachers gave him the lowest possible passing grade for his work in this area, submitted as part of the requirements for a doctoral degree.

Audubon, John James

1785—1851

French-born Audubon came to America at age eighteen and became its best known authority on birds. Although he is best remembered for his painting of North American birds, he was also praised for his studies of bird migrations.

Avery, Oswald Theodore

1877—1955

Although trained as a physician, the Canadian Avery is best known for his studies of a bacteria called pneumococci—the pneumonia-causing germs. Avery found that the differences between bacteria which caused disease and those that did not were determined by the organisms' DNA and not protein as was previously believed.

- Avicenna 980--1037
 The Arab physician Avicenna is best remembered for his medical text, *Canon of Medicine*, in which he described causes, cures, and symptoms of many diseases. Because of political problems in his country, he worked for several Muslim rulers and was almost executed during a sudden military move.
- Avogadro, Medeo 1776--1856
 Avogadro, an Italian physicist whose name describes the number of molecules in a mole of any substance, is best remembered for the basic principle that equal volumes of gases at the same temperature and pressure contain an equal number of molecules. Unfortunately, Avogadro's work was not well accepted until after his death.
- Bacon, Francis 1561--1626
 Born the son of an important government official, Bacon was one of the earliest supporters of experimental and scientific methods in solving problems. In an attempt to study the slowing of the decay process by cold, he became ill and eventually died of bronchitis.
- Bacon, Roger 1220--1292
 One of the leading figures in the development of science in the Middle Ages, Bacon became known as the founder of experimental science. His opinions were not always shared by his fellow scholars. Bacon spent 15 years in prison, and his most significant work, *Opus Maius*, was not published until many years after his death.
- Banting, Sir Frederick Grant 1891--1941
 Canadian-born Sir Frederick Grant Banting, awarded the Nobel Prize in 1923, was the first scientist to isolate from the pancreas the hormone insulin, which controls diabetes. A major in the Canadian Army during World War II, he was killed in an airplane crash while on his way to England.
- Beadle, George Wells 1903--
 The American geneticist Beadle, with his co-workers Tatum and Lederberg, experimented with bread mold and proved that genes act by regulating specific chemical processes. In 1958, Beadle shared the Nobel Prize in medicine and physiology for these important studies.
- Beaumont, William 1785--1853
 As an American frontier physician, Beaumont gained fame for his studies of the process of digestion. One part of Beaumont's work was ended when his patient (who was being treated for a shotgun wound to the stomach) escaped.
- Becquerel, Antoine Henri 1852--1908
 A French physicist, Becquerel shared the 1903 Nobel Prize with Pierre and Marie Curie for the discovery of natural radioactivity. Becquerel was a professor of physics at the Museum of Natural History in Paris, a position held by both his father and grandfather.
- Bernard, Claude 1813--1878
 The French-born physiologist Bernard studied the mammalian digestive processes and discovered that the liver converts sugar to animal starch called glycogen. Failing in his attempts to become a playwright, Bernard chose science as his second career.
- Berzelius, Jons Jakob 1779--1848
 Jons Jakob Berzelius, a noted Swedish chemist, originated the system of writing chemical symbols and formulas, representing all known elements and compounds. Although he was a brilliant chemist, young Berzelius was a poor student who almost failed in medical school.

Bohr, Niels Henrik

1885—1962

Danish-born, Nobel Prize-winning Bohr expanded the science of chemistry with his theory of the structure of the atom. During World War II, Bohr arranged the escape of many Danish Jews. He spent the rest of his life promoting peaceful uses of nuclear energy.

Boltzmann, Ludwig Edward

1844—1906

Boltzmann, an Austrian physicist, made important contributions to the theory of radiation and the kinetic theory of gases. He was a strong supporter of atomism—the theory that the atom is made up of tiny, simple particles that cannot be destroyed or divided—and may have committed suicide because he felt that the anti-atomists had won.

Boyle, Robert

1627—1692

An Irish scientist, Boyle's experiments with gases led him to discover the inverse relationship between volume and pressure of gases, known as Boyle's law. His continual reliance on experimentation helped to establish the experimental method in chemistry and physics, which is reinforced in the scientific community today.

Brahe, Tycho

1546—1601

Born into Danish nobility, Brahe developed a systematic approach for observing the planets and stars. Brahe lost his nose in a midnight duel and wore a false nose of metal for most of his life.

Calvin, Melvin

1911—

Calvin, an American biochemist, received the 1961 Nobel Prize for his studies of the dark reactions of photosynthesis. Using radioactive carbon dioxide, he traced the chemical reactions that occur when a plant changes carbon dioxide and water into sugar—now called the Calvin cycle.

Carothers, Wallace Hume

1896—1937

Wallace Carothers, an American chemist, is best known for his development of the fiber known as nylon. At age forty-one, Carothers committed suicide after the death of his twin sister.

Carver, George Washington

1864—1943

Born a slave on a farm near Diamond, Missouri, Carver became an internationally famous agricultural chemist. In addition to his scientific contributions, Carver worked to bring higher education to Southern blacks and to improve relations between blacks and whites.

Cavendish, Henry

1731—1810

English chemist and physicist Cavendish discovered many fundamental laws of electricity as well as measuring the density of the earth. A shy man, Cavendish spent most of his life in scientific research, made few friends, and even insisted on dying alone.

Celsus, Aulus Cornelius c. 10 B.C.—unknown

Celsus, an ancient Roman who collected information on all branches of knowledge, wrote a summary of Greek knowledge in eight volumes. Like many scientists of his time, Celsus was a member of one of the highest royal families of Rome.

Chadwick, Sir James

1891—1974

Experiments of the English-born Chadwick led to his discovery of the subatomic particle called the neutron, for which he was awarded the Nobel Prize in 1935. Knighted in 1945, Sir Chadwick headed the team of British scientists working on the atomic bomb project during World War II.

Chargaff, Erwin 1905—

The Austrian-American biochemist Chargaff developed the technique of using paper chromatography to establish the base-pairing rule in DNA, which allowed Watson and Crick to determine DNA structure. Chargaff considered his profession a branch of natural philosophy.

Clausius, Rudolf 1822—1888

A German physicist, Clausius's studies of heat, work, and energy degradation helped establish thermodynamics as a science. A serious German nationalist and the son of a Prussian military officer, Clausius was wounded in the Franco-Prussian War, in which he served as a medic.

Copernicus, Nicolaus 1473—1543

Considered the founder of present-day astronomy, the Polish-born Copernicus developed the theory that the earth is a moving planet in a sun-centered universe. Since his ideas were not widely accepted, Copernicus's book on the structure of the solar system, *De Revolutionibus*, was not removed from a list of banned books until 1853.

Crick, Francis Harry Compton 1916—

Crick, an English biochemist, shared the 1962 Nobel Prize in medicine and physiology with J. D. Watson and M. H. F. Wilkins for their double helical model of the DNA molecule. Originally a physicist, Crick helped to develop radar during World War II.

Curie, Marie Sklodowska 1867—1934

Marie Curie, with her husband, Pierre, discovered the radioactive elements polonium, radium, and ionium and studied their chemical properties, for which she received two Nobel Prizes: in physics in 1903 and in chemistry in 1911. Ironically, Marie died of leukemia from overexposure to radioactivity, which can also destroy cancer cells.

Curie, Pierre 1859—1906

Pierre Curie's research on the magnetic properties of metals preceded his joining his wife in their studies on radioactivity. Unfortunately, Pierre was run over by a horse-drawn carriage and died at the age of forty-seven.

Cuvier, Georges Leopold
Chretien Frederic Dagobert 1769—1833

The French naturalist Cuvier began the sciences of comparative anatomy and paleontology through his own studies of animal structure. While teaching at the College of France, Cuvier was awakened by a student dressed as a devil who threatened to eat the professor. He replied, "All creatures with hooves and horns are herbivores; you cannot eat me"—and went back to sleep.

Dalton, John 1766—1844

The unit of atomic weight was named in honor of John Dalton, an English chemist who made the first table of atomic weights. Because of his Quaker beliefs, Dalton refused to accept the honors bestowed upon him.

Darwin, Charles 1809—1882

Darwin, an English naturalist, became famous for his theories on evolution based on a natural selection of species. Darwin's father allowed him to sail around the world on the H.M.S. *Beagle* only after being convinced by Darwin's Uncle Josiah.

DeVries, Hugo Marie 1848—1935

The Dutch botanist DeVries believed that new species of plants and animals occur as a result of mutations. DeVries was one of three scientists in 1900 who independently worked out the laws of inheritance described by Mendel 100 years before.

Ehrlich, Paul 1854—1915

Working in the field of immunity, German bacteriologist Paul Ehrlich discovered the chemical Salvarsan as a cure for syphilis and received the 1908 Nobel Prize. Known for his ill-natured personality, Ehrlich made few friends in the laboratory.

Einstein, Albert 1879—1955

Born in Germany and considered one of the greatest scientists of all time, Einstein is best known for his theory of relativity. Other major contributions include his explanation of the photoelectric effect produced by a quantum of light and analysis of Brownian motion. As a child, Einstein was somewhat slow to develop, and it was feared that he was retarded.

Faraday, Michael 1791—1867

Michael Faraday, an English chemist and physicist, was a great contributor to science: he discovered how electricity could be moved through wire by a magnet; he formulated the laws of electrolysis; he was the first to liquify gases and distill benzene from fish oil. Faraday's first job was with a bookbinder, which gave him access to learning through reading books.

Fermi, Enrico 1901—1954

An Italian-American physicist who won the 1938 Nobel Prize, Fermi proved that slow neutrons can produce radioactive atoms which can release great amounts of energy. After escaping the Fascist regime in Italy, Fermi continued his research in the United States and produced the first nuclear chain reaction in 1942.

Fischer, Emil Hermann 1952—1919

A German chemist, Fischer won the 1902 Nobel Prize for a wide range of research. He discovered a method of identifying sugars; did research on proteins and dyes; and established the importance

of the three-dimensional structure of molecules. After the loss of two sons and his suffering from cancer, Fischer took his own life.

Fleming, Sir Alexander 1881—1955

The British bacteriologist Fleming discovered the bacteria-killing protein called lysozyme and the green mold called *penicillium*. From this, the life-saving antibiotic penicillin was purified, and for his work, Fleming received the 1945 Nobel Prize.

Franklin, Benjamin 1706—1790

A jack-of-all-trades and master of many best describes Franklin, an American statesman and scientist whose famous encounter with a kite in a thunderstorm led to the invention of the lightning rod. The fifteenth of seventeen children, Franklin came from a poor family; but his leadership talents enabled him to become a successful American ambassador.

Galen c. 130—c. 200

Often called the Father of Experimental Physiology, Greek physician Galen served in the Roman court of Marcus Aurelius. His detailed studies of anatomy made him an authority in the field of medicine for over a thousand years after his death.

Galilei, Galileo 1564—1642

A thorough experimenter in astronomy and physics, the Italian Galileo discovered the laws of the pendulum and of falling bodies and made many astronomical observations. His clever talent in construction produced many telescopes and compasses, and he was also a talented musician and artist.

Gauss, Karl Friedrich 1777—1855

German mathematician and astronomer Gauss proved the fundamental theorem of algebra,

mathematically determined the elliptical orbit of a planet, and developed the universal theory of the earth's magnetism. So promising a student was Gauss that his education was funded by Ferdinand, Duke of Brunswick.

Gibbs, Josiah Willard 1839—1903

Considered the Father of Modern Physical Chemistry, Gibbs is famous for his mathematical concepts of free energy and chemical potential as the driving force of chemical reactions. As with Einstein, Gibbs's work was not fully understood by his peers.

Goddard, Robert Hutchings 1882—1945

Pioneering the science of rocketry and space flight, American physicist Robert Goddard developed the mathematics of rocket action. While German rocket experts praised his work, many other scientists ridiculed him as a "moon man."

Goeppert-Mayer, Maria 1906—1972

Maria Goeppert-Mayer, the German-American physicist, suggested the arrangement of particles within atoms—a nucleus containing protons and neutrons with electrons arranged in the outer atom. In 1933, she received her Ph.D. at the University of Gottinger and promptly moved to the United States.

Gray, Asa 1810—1888

The American botanist Asa Gray received a degree in medicine but became a leading authority on plant life and natural history. Despite the antievolutionary climate of his time, Gray vigorously defended the theories of Darwin.

Grew, Nehemiah 1641—1712

An English botanist and physician, Grew is best known for his studies of the reproductive organs of flowers and the comparative anatomy of animals. His father, who fought on the losing

side in the English Civil War, sent young Nehemiah to the Netherlands to study medicine.

Hales, Stephen 1677—1761

The English botanist Stephen Hales is known as the Father of Plant Physiology, is noted for his experimental approach to research on plant growth, and was the first to recognize that a portion of the air contributes to the nourishment of plants. Hales's book, explaining his discoveries, was the last to be officially supported by the Royal Society's president, Isaac Newton.

Halley, Edmund 1656—1742

In 1662, English astronomer Halley calculated the orbit of the comet which bears his name and accurately predicted its return. He is also noted for his accurate mapping of the stars and his determination of an accurate way to measure the distance from the sun to the earth.

Harvey, Sir William 1578—1657

Sir William Harvey was an English physician who first described the circulation of blood through the heart and body. His theories were attacked by followers of Galen, but he lived to see full credit given to his work and was given the title of Father of Modern Physiology.

Heisenberg, Werner Karl 1901—1976

A German physicist and 1932 Nobel Prize winner, Heisenberg is responsible for development of the uncertainty principle, which states that no accurate measurement of a body's position and velocity can be made at the same time. Heisenberg was in charge of research on the atomic bomb during World War II; but after the war, he resided in democratic West Germany.

Helmholtz, Hermann von 1821—1894

German physicist and physiologist Helmholtz is best known for his work in proving the law of

conservation of energy as well as his studies of the eye and the ear. Helmholtz devised a way to measure the speed of a nerve pulse, which his teacher said could not be measured.

Herschel, Sir William 1738—1822

Herschel is credited with founding the present-day system of star astronomy through his research of the heavens with self-constructed telescopes. His musical talent gave him the financial security to pursue his interests in mathematics and optics.

Hershey, Alfred 1908—

With fellow American biologist Martha Chase, Alfred Hershey conducted experiments confirming the theory that nucleic acids were the basis of heredity. In 1969, Hershey shared the Nobel Prize for his discoveries involving the mechanism of replication and the genetic structure of viruses.

Hippocrates of Cos 460 B.C.—377 B.C.

Known as the Father of Medicine, the Greek physician Hippocrates was a prolific writer on the subjects of medicine and biology. His influence is said to have given the medical profession a sense of duty to humanity, which is reflected in the Hippocratic oath taken by all medical doctors.

Holmes, Oliver Wendell 1809—1894

This American essayist, physician, and physiologist discovered the contagious disease childbed fever, for which he recommended that physicians wash their hands between examining patients. As a youth, Holmes was bored by the study of law and then turned to medicine.

Hooke, Robert 1635—1703

A man of humble beginnings, this English experimental scientist is known for Hooke's law,

which states that the force necessary to return a spring to its equilibrium position is proportional to the distance it is displaced. He is also known for his naming of cells from his microscopic observations of cork. An argumentative fellow, Hooke was continually involved in disputes and even criticized the work of Isaac Newton.

Humboldt, Alexander von 1769—1859

German scientist and geographer Humboldt studied ocean currents, volcanoes, waterways, and the earth's magnetism and collected over 60,000 plants. At the age of twenty-five, Humboldt was left with an inheritance which allowed him to spend the rest of his life in enthusiastic research and travel, earning him the title Founder of Geophysics.

Hutton, James 1726—1797

James Hutton, a Scottish philosopher, physician, and geologist, is known as the Father of Geology and was the first to determine the importance of heat in the formation of the earth. His book, *Theory of the Earth*, opposed the establishment's belief in the biblical interpretation of creation.

Huygens, Christian 1629—1695

A Dutch physicist, mathematician, and astronomer, Huygens was the first to study the polarization of light and developed the wave theory of light. While a member of the Royal Society, Huygens employed Galileo's theory of the pendulum in building the first "grandfather's clock."

Hypatia 370—415

Hypatia was the only woman scholar of ancient times and is known for her mathematical and philosophical writings, for inventing the astrolabe, and for measuring and distilling water. During an outbreak against non-Christians, she was murdered for upholding her traditional Greek religious beliefs.

Jenner, Edward

1749—1823

Because of the keen observations and experiments by Edward Jenner, an English physician, vaccination was found to be an effective means of preventing smallpox. Acting on a hunch, Jenner inoculated a young boy who previously had cowpox, with smallpox. He thereby immunized both types of virus and gained fame for himself.

Jerne, Niels

1912—

Swiss immunologist and 1980 Nobel Prize winner Jerne is best known for his model of antibody-antigen interaction. This model suggested that the information for producing an antibody is present in the host before it comes into contact with the antigen.

Joliet-Curie, Irene

1897—1956

The French physicist Joliet-Curie worked with her husband, Frederic, to determine that radioactivity was not confined to the heavy elements such as uranium but could also be prepared artificially with smaller atoms. The eldest daughter of Pierre and Marie Curie, Joliet-Curie chose to keep her name after marriage since her parents, Marie and Pierre, had no sons.

Joule, James Prescott

1818—1889

James Joule, an English physicist interested in the relationship between work and heat, developed Joule's law, which explains that heat is produced in an electric conductor. Joule, in whose honor the unit of work was named, was a brewer and never held an academic position.

Kelvin, Lord William Thomson 1824—1907

A Scottish physicist, Kelvin's work on electromagnetism and thermodynamics was the basis for designation of the First Law of Thermodynamics (the conservation of energy). He also introduced the idea of absolute temperature, the scale of which bears his name. At the age of ten, Kelvin enrolled in Glasgow University, and in

1892, in recognition of his contribution to science, he was given the title of Baron Kelvin of Largs.

Kepler, Johann

1571—1630

Known as the Father of Modern Physical Astronomy, Kepler was a German mathematician and astronomer who determined the elliptical orbits of planets, described the lunar influence on tides, and discovered three laws of planetary motion. Kepler may have also written the first piece of science fiction with his story of a man who traveled to the moon.

Kirchhoff, Gustav Robert

1824—1887

A German physicist responsible for the development of spectral analysis, Kirchhoff found that a chemical analysis of a substance could be made by studying its unique spectral lines. Several principles of physics bear Kirchhoff's name.

Koch, Robert

1843—1910

Koch, a German bacteriologist and 1905 Nobel Prize winner, established bacteriology as a separate science with his use of agar and formulation of Koch's postulates for identifying causative agents. He discovered the separate germs which cause tuberculosis, cholera, bubonic plague, and sleeping sickness. Koch helped to train other Nobel Prize winners, such as Behring and Ehrlich, and the inventor of the petri dish, Julius Petri.

Krebs, Sir Hans Adolf

1900—

In 1937, German-British biochemist Krebs discovered the energy-liberating citric acid cycle present in the sugar metabolism of living systems. He also determined how urea is formed, ridding the body of excess nitrogen. A 1953 Nobel Prize winner, Krebs fled Germany when Hitler came into power.

Lamarck, Jean Baptiste Pierre
Antoine de Monet, Chevalier de 1744—1829

Although he is known as the Founder of Modern Invertebrate Zoology, Lamarck is best known for his pre-Darwinian theory of evolution, which claimed that acquired characteristics are inherited. Lamarck was the eleventh child of a poor aristocratic family and did not settle on a career in zoology until he was in his forties.

Landsteiner, Karl 1869—1943

Landsteiner, an American immunologist and 1930 Nobel Prize winner, discovered human blood groups—a great benefit for 21 million wounded in World War II—and established immunochemistry as a branch of science. The shy, reserved Landsteiner did not like publicity and failed to tell his own family of his Nobel Prize.

Laplace, Pierre Simon de 1749—1827

A French mathematician and physical scientist, Laplace wrote *Celestial Mechanics*, which was complementary to the work of Newton; he also contributed an equation for the physical concept of "potential." Notorious for stating in his writings, "it is obvious" that one equation derives from another, Laplace's calculations were frequently complicated processes and not obvious at all.

Lavoisier, Antoine Laurent 1743—1794

A Frenchman and Founder of Modern Chemistry, Lavoisier realized the importance of oxygen in the process of combustion, helped in establishing the metric system, and explained that any chemical action could be expressed by an equation. For his investments in a tax collecting firm, he was guillotined during the French Revolution.

Lawrence, Ernest Orlando 1901—1958

An American physicist and Nobel Prize winner, Lawrence invented the cyclotron and was

instrumental—through his research—in the development of nuclear science. Named in his honor are the Lawrence Radiation Laboratory, the Lawrence Hall of Science, and the element 103-Lawrencium.

Leeuwenhoek, Anton van 1632—1723

The Dutch Leeuwenhoek has been associated with the microscope because of the hundreds of reports he sent to the Royal Society describing insects, parasites, capillaries, blood cells, and bacteria which he had observed. A draper by profession, the poorly schooled Leeuwenhoek enjoyed microscopy and lens-making as hobbies.

Leonardo da Vinci 1452—1519

Even if he had not been a great artist, Leonardo da Vinci's intellectual range, energy, and originality would have set him apart as one of the grand geniuses of human history. His insight approached prophecy in the field of mechanics, astronomy, optics, and many other fields.

Linnaeus, Carolus 1707—1778

Linnaeus, a Swedish botanist, is known as the Father of Modern Taxonomy by means of his use of binomial nomenclature in classification systems, e.g., "Homo sapiens" (man, wise). Linnaeus's taxonomic system supported the theories of Darwin and Wallace, but he personally was not a believer in the theory of evolution.

Lister, Joseph 1827—1912

The English surgeon Lister introduced the chemical treatment for wounds to protect against infection, using carbolic acid. In 1897, Lister was made a baron for his introduction of antiseptic surgery and his advancements in the prevention of infection.

Lyell, Charles 1797—1875

A Scottish scientist and inspiration for young Darwin, Lyell discussed the element of geologic time in *The Principles of Geology*, in which he stated that some fossils were 240 million years old. Lyell also speculated on human origins in his book *The Antiquity of Man*, published in 1863.

Maxwell, James Clerk 1831—1879

British physicist Maxwell is responsible for the expansion of the second law of thermodynamics to include the movement of particles with different velocities and random motion. He also developed a mathematical proof of the electromagnetic theory of light. At age fifteen, Maxwell delivered a paper on Cartesian ovals to the Royal Society of Edinburgh.

McClintock, Barbara 1902—

American biologist McClintock revolutionized the study of genetics with her discovery of "mobile genetic elements," contradicting the idea of the constancy of the genome. McClintock's work preceded the knowledge of the structure and formation of DNA, and in 1983, she received the Nobel Prize.

Medawar, Peter Brian 1915—

British immunologist Medawar received the 1960 Nobel Prize for his explanation of immunological tolerance. He reasoned that each individual possesses unique immunological markers on all cells. Because of the many serious burn injuries suffered during World War II, Medawar became interested in studying skin grafting and the reasons why some grafts were rejected by their recipients.

Mendel, Johann Gregor 1822—1884

Through careful observations and detailed records kept while working in his monastery

garden, Mendel determined the basic laws of heredity. Although widely acclaimed today, Mendel's work was largely ignored by his peers.

Mendeleyev, Dmitry Ivanovich 1834—1907

From humble beginnings, Russian chemist Mendeleyev is revered for his formulation of the periodic table in which the elements are arranged according to their atomic weights. Mendeleyev believed that some elements were still undiscovered, for which he left gaps in his table, and was consequently considered somewhat of a mystic.

Meyerhof, Otto Fritz 1884—1951

A German-American biochemist and 1922 Nobel Prize winner, Meyerhof demonstrated that the production of lactic acid in muscle tissue is due to glycogen breakdown when oxygen is depleted. The biochemical pathway by which glycogen is converted to lactic acid bears his name, the Embden-Meyerhof pathway.

Miller, Stanley Lloyd 1930—

American chemist Miller experimented to mimic conditions of the earth as living forms first emerged; he used simple inorganic compounds and an energy source to produce simple organic molecules, including the amino acids alanine and glycine. He performed his famous experiment during his graduate studies.

Millikan, Robert Andrews 1868—1953

The American physicist Millikan received the 1923 Nobel Prize for his calculation of the charge of a single electron; he also verified experimentally Einstein's calculations on the photoelectric effect. Because of his deeply religious beliefs, Millikan actively sought to reconcile science and religion.

Mitchell, Maria 1818—1889

The first American female astronomer and the first female member of the American Academy of Arts and Science was Maria Mitchell, who discovered a comet in 1847. An advocate for equal educational opportunities for women, she held a professional position at the women's college of Vassar.

Mitchell, Peter D. 1920—

An English chemist, Mitchell is responsible for the chemiosmotic hypothesis, for which he won the 1978 Nobel Prize. Studying mitochondria, Mitchell determined that ATP formation is coupled to hydrogen ions across inner mitochondrial membranes. His ideas have since been applied to other cellular organelles.

Morgan, Thomas Hunt 1866—1945

Thomas Hunt Morgan, an American geneticist and 1933 Nobel Prize winner, studied fruit flies (*Drosophila*) to establish the concepts of gene-linkage and crossing over. Morgan's famous relative was Francis Scott Key, who wrote the words to "The Star-Spangled Banner."

Muller, Hermann Joseph 1890—1967

An American geneticist, Muller won a Nobel Prize for experiments with radiation, which resulted in mutations. Muller was an avid supporter of the establishment of sperm banks so that individuals of worth would have their genes passed to another generation.

Newton, Sir Isaac 1642—1727

The noted English natural philosopher, astronomer, physicist, and mathematician Sir Isaac Newton developed the theory of gravitation and formulated the three basic laws of mechanics, Newton's Laws of Motion. While at his mother's farm, the young Newton observed an apple falling to the ground, causing him to wonder

whether the same force that pulled it down also held the moon in place.

Nirenberg, Marshall Warren 1927—

Recipient of the Nobel Prize in 1968, American biochemist Nirenberg made advances in deciphering the genetic code. Nirenberg determined which triplet sequence of nucleotides specified which amino acid.

Oppenheimer, Robert 1904—1967

American physicist Oppenheimer led a large group of scientists at the Los Alamos Scientific Laboratory in the development of the first nuclear weapon employing atomic fission reactions. Besides his efforts in nuclear science, Oppenheimer also made a number of contributions to theoretical physics.

Pasteur, Louis 1822—1895

Pasteur was a French chemist who developed the germ theory of disease. He achieved fame for his experiments, which refuted the theory of spontaneous generation of life. The process of pasteurization, a gentle heating to kill harmful microorganisms, was named in honor of Pasteur.

Pauli, Wolfgang 1900—1958

Austrian-American physicist Pauli is best known for his exclusion principle, which states that only two electrons can occupy a particular orbital level of an atom; for this, he won the 1945 Nobel Prize. Despite his intelligence, Pauli was known to be clumsy in the laboratory and a stumbling lecturer in the classroom.

Pauling, Linus Carl 1901—

Pauling, an American chemist, is known for his work on molecular structure and for formulating the concept of resonance (the distribution of electronic charge among bonded atoms), for

which he received the 1954 Nobel Prize. In 1963, he won a second Nobel Prize for Peace for his advocacy of nuclear disarmament, making him one of three to receive two Nobel Prizes.

Pavlov, Ivan Petrovich 1849—1936

Pavlov was a Russian physiologist who studied gastric secretion in dogs; he also demonstrated the importance of the autonomic nervous system in the physiology of digestion, leading to his studies on reflex conditioning. Despite his anti-communist advocations, Pavlov became an accepted member among Russian scientists.

Planck, Max 1858—1947

A German physicist, Planck was the first to use the term "quantum" and made significant contributions to quantum mechanics. A fundamental constant of the universe, Planck's constant was so named in his honor, and in 1918, he was awarded the Nobel Prize. Planck's son Erwin was executed in 1944, accused of plotting against Hitler's life.

Priestley, Joseph 1733—1804

The English chemist Priestley is credited with the discovery of oxygen. A good friend of Benjamin Franklin and Thomas Jefferson, Priestley was the first to mix carbon dioxide in water, creating the first soda water.

Ptolemy, Claudius c. 100—c. 170

Also called Claudius Ptolemaeus, Ptolemy was a great astronomer and geographer of ancient times and was considered an authority until 1543. He rejected the idea of the earth as a moving body, and his serious treatment of astrology, helped to spread that superstition.

Reed, Walter 1851—1902

An American military surgeon, Reed discovered that yellow fever was transmitted by a mosquito. He demonstrated that the agent which passed this disease to humans was a virus. In commemoration of his achievements, the military hospital in Washington, D.C., was named in his honor.

Roentgen, Wilhelm Konrad 1845—1923

The German physicist Roentgen was the first to use the term "X-ray" following his discovery of a radiation source which he did not understand. Roentgen was awarded the 1901 Nobel Prize, and within a year of his discovery, over 1,000 papers on X-rays were published.

Rutherford, Lord Ernest 1871—1937

A British physicist, Rutherford is noted for his model of the nuclear atom, his theory of the radioactive disintegration of elements, and his determination of the nature of alpha particles. Throughout his life, Rutherford made original scientific contributions, including the changing of one element to another by manipulation.

Sabin, Albert Bruce 1906—

The American physician and virologist Sabin made many studies into the causes and origins of viral disease in humans, particularly poliomyelitis. His work led to the development of an oral vaccine for its prevention. Ironically, Sabin caught a viral disease in the 1980s which left his legs paralyzed for a time.

Sagan, Carl 1934—

An American astronomer and educator, Sagan is an authority on planets, the origin of life on earth, and extraterrestrial biology. Recently, he has become an avid spokesperson against nuclear warfare and its catastrophic environmental consequences.

Salk, Jonas Edward

1914—

The American physician Salk was a principal fighter in the war against poliomyelitis with his development of the Salk vaccine, given in three doses. By the summer of 1961, the incidence of reported cases of polio was down by 96 percent.

Schrodinger, Erwin

1887—1961

The Austrian physicist Schrodinger proved the mathematical foundation for wave mechanics and the mathematical relationship of the electron to the atom bears his name. Because of his anti-Nazi sentiments, Schrodinger moved to Dublin, Ireland, when Hitler came to power.

Seaborg, Glenn Theodore

1912—

The American chemist Seaborg discovered atomic elements 97 through 102, for which he shared the Nobel Prize in chemistry in 1951. As head of the Atomic Energy Commission, Seaborg has taken an active role in education, particularly in the area of science.

Teller, Edward

1908—

An American physicist, Teller worked with a group of scientists to formulate a molecular orbital theory, which explains the phenomenon of the chemical bond and led to the development of the first hydrogen bomb. Besides his scientific endeavors, Teller has been an outspoken critic of the totalitarian governments of Eastern Europe.

Theophrastus

c. 370 B.C.—c. 285 B.C.

A Greek botanist who named over 550 plant species, Theophrastus is known as the Founder of Botany. Although he inherited Aristotle's library and carried out his work, Theophrastus's writings have been largely lost over time.

Thomson, Sir Joseph John

1856—1940

Thomson, an English physicist and Nobel Prize winner, was able to describe the electron as a negatively charged particle based on his own experimentation. No fewer than seven of his associates also received the Nobel Prize, including his son, G. P. Thomson.

Urey, Harold Clayton

1893—1981

An American physical chemist, Urey discovered the element deuterium (^2H), after which accurate measurements of the atomic weights of hydrogen and oxygen were made, as well as the discovery of oxygen isotopes. During World War II, Urey was in charge of the separation of isotopes in the Manhattan Project.

Vesalius, Andreas

1514—1564

A Flemish anatomist, Vesalius was able to document human anatomy accurately. With the aid of artists, Vesalius compiled the book *On the Structure of the Human Body*, which is considered one of the great books in the history of science.

Watson, James Dewey

1928—

The creative genius of Watson led to the double helical model of DNA, which was correlated to the physical data of Wilkins and the chemical data of Chargaff. In 1962, he received the Nobel Prize, along with his associates F. H. C. Crick and M. H. F. Wilkins.

Wohler, Friedrich

1800—1882

The German chemist Wohler disproved the concept of vitalism, which states that organic compounds possess a vital force which cannot be reproduced in the laboratory. Although he was an inorganic chemist, Wohler noted that crystals of urea, an organic waste product, formed upon heating ammonium cyanate.

Woodward, Robert Burns 1917—1979

Woodward, an American chemist, developed techniques for synthesizing complex organic compounds, for which he received the 1965 Nobel Prize. Among his contributions to science are his synthesis of cholesterol and chlorophyll and his deduction of the structure of penicillin.

Wu, Chien Shiang 1915—

The Chinese-American physicist Wu disproved the theory of parity, which stated that phenomena of nature look the same even if observed with a mirror. Born in China, Wu came to the United States to pursue graduate studies at Berkeley, worked on the Manhattan Project, and was the first woman physicist elected to the National Academy of Sciences.

Young, Thomas 1773—1829

Known as the Founder of Physiological Optics, the English physicist Young discovered accommodation, the mechanism by which the lens of the eye changes shape. He investigated interference phenomena of light and the elasticity of solid objects and was the first to use the word "energy" in its modern sense. Besides his scientific pursuits, Young helped to decipher hieroglyphics, including the inscription on the Rosetta stone.

APPENDIX II: SCIENTIFIC DISCOVERIES (That Elementary Students Should Study)

AERODYNAMIC THEORY

The theories of air flow, lift, and drag developed by Theodore von Karman and others have allowed aerospace technology to proceed from the biplane to the shuttle craft. Though the Wright brothers were the first to fly in a man-made flying craft, their success was based on trial and error rather than aerodynamic theory.

ALCHEMY

As one of the earliest forms of chemistry, alchemy involved the search for "the philosopher's stone," which would change metals into gold and discover the "elixir of life" to provide long life and good health. As a modern science, alchemy can be related to the artificial creation of elements, most of which are radioactive and unstable, as exemplified by the discoveries of Glenn Seaborg and Edward McMillan in the 1940s.

ANTIBIOTICS

Antibiotics are substances made from living organisms, usually bacteria or molds, which kill harmful bacteria without harming the host. Following the work of Ehrlich, Domagk, and Fleming, Selman Waksman demonstrated that antibiotics could cure even the resistant disease tuberculosis.

BIG BANG THEORY

The term for the big bang theory was first used by George Gamow in 1946. It states that the universe originated billions of years ago from the explosion of a large mass, so that pieces are still flying apart. It is supported by the red shift or Doppler effect observed in the spectra from distant galaxies.

BINOMIAL NOMENCLATURE

Biological classification is a grouping of living organisms into categories based on their similarities, e.g., structure. The present system for this classification, called binomial nomenclature, was introduced by the Swedish botanist Carolus Linnaeus and implies the use of two terms, e.g., "Homo sapiens" (man, wise). The basic unit of binomial nomenclature is the species, members of which are capable of mating and producing fertile offspring.

BLOOD TYPING

The primary blood groups are defined by two proteins or blood factors which make up four types of human blood: A, B, both (AB), or neither (O). Karl Landsteiner's discovery of these proteins in 1900 made possible successful blood transfusions and eventually even tissue and organ transplants. Other applications of blood typing can be made in forensic medicine and anthropological research.

BOYLE'S LAW

Boyle's law, attributed to Charles Boyle in 1662, expresses the pressure-volume relation for an ideal gas. It states that if a gas is kept at constant temperature, its pressure will increase as its volume decreases.

BUOYANCY

The lifting effect of a fluid upon a body wholly or partly submerged in it, known as buoyancy, was carefully studied by the Greek philosopher Archimedes in 250 B.C. Archimedes's principle states that the buoyant force is equal to the weight of the fluid that is displaced by an object.

CELL THEORY

In 1665, Robert Hooke coined the term "cell" on the basis of his microscopic observations of cork. The cell theory is the concept that all living things are made of cells and is a unifying principle of modern biology. In 1805, Lorenz Oken first presented the idea that the cell is a fundamental, irreducible unit of life.

CIRCULATION OF BLOOD

That blood circulates through the human body was shown experimentally by Sir William Harvey (1578—1657), who showed that the heart performed a pump-like function. This discovery, plus Harvey's quantitative methods of biology, propelled human physiology into the modern era.

COMPETITIVE EXCLUSION PRINCIPLE

First recognized by the Russian biologist G. F. Gauss, the competitive exclusion principle states that two species cannot exist on the same limiting resource. The word "limiting" must be included in this statement because only resources that limit population growth provide the basis for competition.

COMPUTER

Computers are generally defined as devices capable of accepting information, processing the information in a specified manner, and supplying the information resulting from the process. Electronic digital computers were invented during World War II to help in cracking Nazi codes, but they have since taken on broader roles. With their ability to be programmed in narrowly defined fields, they can mimic experts, e.g., diagnosing and prescribing. This application is referred to as artificial intelligence.

CONSERVATION

Conservation is the management, protection, and wise use of natural resources. The term, coined

by Gifford Pinchot of the U.S. Forest Service, became popular in the early 1900s as conservationists began preserving forests and wildlife. The term comes from two Latin words—"servare," which means to keep or guard, and "con," meaning together.

CONSERVATION OF ENERGY (FIRST LAW OF THERMODYNAMICS)

Conservation of energy, the first law of thermodynamics, states that in any system, the total of all forms of energy will neither increase nor decrease but that these forms may interchange. Research by scientists such as Carnot, Mayer, Joule, and Helmholtz led to this unifying principle.

DDT

Discovered by Paul Muller in 1939, dichlorodiphenyl-trichlorethane (DDT) was the first of many synthetic insecticides used to control insect pests and vectors of disease. The two important outcomes of its use were that (1) subsequent insect populations became resistant; and (2) there was a buildup of the toxic substance through the food chain.

DEDUCTIVE REASONING

Deductive reasoning is the process by which we draw conclusions by logical inference from given premises. Mathematics and logic rely heavily on this process, whereas the scientific method requires a combination of induction and deduction.

DNA

The double helical structure of deoxyribonucleic acid (DNA) was explained in 1953 by James Watson and Francis Crick, thanks in part to the X-ray crystallography studies of Rosalind Franklin. The description of this chemical transmitter of genetic information made possible the manipulation of genes, the synthesis of proteins, and continued discoveries of the cell at the molecular level.

ELECTRICITY

Electricity is a form of energy which occurs as a result of the existence of electrical charge. The understanding of electricity has led to the invention of motors, generators, telephones, television, and computers.

ELECTROMAGNETIC RADIATION

Electromagnetic radiation is the passage of energy through space or through substances in the form of waves which have both an electrical and magnetic component. Light, radio waves, and X-rays are all forms of electromagnetic radiation. James Maxwell suggested that light was an electromagnetic wave when he discovered that an electromagnetic field radiates outward from its source at the speed of light.

ELECTRON MICROSCOPE

An instrument which uses a beam of electrons instead of light rays to magnify objects, the electron microscope can be used to see objects as small as bacteria and viruses. It was used as early as 1931 in hospitals and research laboratories. There are two kinds of electron microscopes: (1) the transmission electron microscope, which passes electrons from an electron gun through a specimen and onto a fluorescent screen; and (2) the scanning electron microscope, which moves electrons across a specimen with scanning coils, forming a magnified image on a television screen.

ENTROPY (SECOND LAW OF THERMODYNAMICS)

First used by German physicist Rudolf Clausius, entropy is a measure of the disorder in a system. The second law of thermodynamics states that entropy can stay the same in a reversible process or increase in an irreversible process, but can never decrease. An increase in entropy with change denotes a reduced amount of available energy.

EVOLUTION

The unifying principle of evolution states that most organisms produce far more offspring than can possibly survive and that those best adapted to a particular environment live to reproduce. Darwin, an English naturalist, is credited with this theory of natural selection from his book of observations as a naturalist on the HMS *Beagle* in the 1830s. The theory has been strengthened from advances in genetics, statistics, and biochemistry.

GENETIC ENGINEERING

Genetic engineering, or biological manipulation, is the ability to alter genetic structure and place it in a living system in order to produce a desired product, such as the hormone insulin. This ability to splice or recombine genetic information was first performed in the 1970s by Paul Berg, Stanley Cohen, and Herbert Boyer. Although the technology has great promise in the curing of diseases, it has become controversial because of its implications for interfering with human make-up.

GEOLOGIC TIME

One of the great discoveries of all time is that of the age of the earth (over four billion years), the time incorporated in its history, and the scale of this time (in millions and billions of years), called geologic time. The eighteenth century French scientist Georges Louis Leclerc, Comte de Buffon, figured the cooling of the earth alone would have taken 75,000 years; Charles Darwin reasoned that millions of years were necessary for evolutionary change to occur.

GERM THEORY

In the late 1800s, Louis Pasteur and Robert Koch established the germ theory of disease. While Pasteur proved that microbes are living organisms, some of which cause disease, Koch formulated a method for determining which bacteria cause specific diseases (see Koch's Postulates).

HETEROSIS/HYBRIDIZATION

Heterosis or hybrid vigor is the increased vigor and greater yield observed in plants and animals resulting from the crossing of pure but unrelated strains. Although this phenomenon was observed as far back as Darwin, geneticist George Harrison Shull formulated the heterosis concept and tested hybrid corn in the early 1900s. His work eventually resulted in great increases in the yield of corn as well as many other crops.

IDEAL GAS LAWS

The ideal gas law presented by Boyle (1627—1692) states that if a gas is kept at constant temperature, the pressure and volume are in inverse proportion; Charles's (1746—1823) law states that at a fixed volume, the pressure is a linear function of the temperature. These laws are true only for "ideal gases," but they provide approximate values which are very useful.

INDUCTIVE REASONING

Supported by Francis Bacon and popularized by Galileo, inductive reasoning begins with actual experiences and proceeds to generalizations from what has been observed. Scientists realize that no generalizations can be allowed to stand without repeatedly being subjected to testing.

INSULIN

Insulin is a hormone which is produced in the islets of Langerhans in the pancreas and which regulates blood sugar levels. Insulin must be injected, since when given orally, the hormone is destroyed by the digestive system. Insulin, first isolated in 1921 by two Canadian biochemists, F. G. Banting and C. H. Best, is relied on by millions of diabetics to control their condition.

INTERFERON

Produced by the cells of human beings and other mammals in response to viral infections, inter-

feron was isolated by Isaacs and Lindenmann in 1957. It has proved useful in the treatment of diseases such as leukemia, and continuing research may lead to its possible use in prevention of other diseases.

KOCH'S POSTULATES

German bacteriologist Robert Koch formulated four postulates or principles for locating and determining disease-causing microorganisms. These principles are considered fundamental in the study of disease and have been instrumental in conquering diseases such as tuberculosis, anthrax, African sleeping sickness, and Asiatic cholera.

LASER

The word "laser" stands for light amplification by stimulated emission of radiation. The laser is a device which uses the natural oscillations of atoms or molecules for generating a monochromatic, unidirectional beam of light. First constructed in 1960 by American physicist Theodore Harold Maiman, lasers are considered valuable tools and are used in communications, industry, military operations, and scientific research.

LAWS OF INHERITANCE

Formulated by Gregor Mendel in 1866, the laws of inheritance include the law of segregation, whereby hereditary units are paired and then separated, and the law of independent assortment, which states that each pair is inherited independently of other pairs. These laws were further supported by the work of the Dutch scientist Hugo de Vries at the turn of the century.

LAWS OF MOTION

Stated by Sir Isaac Newton in 1686, the three laws of motion state that (1) an object at rest tends to stay at rest unless acted upon by an external force; (2) $F = ma$, meaning force is equal to mass times acceleration; and (3) every action gives rise to a reaction of equal strength but

opposite direction. These laws were used to explain interactions of force, matter, and motion until Einstein's theories provided a more complete explanation.

MICROSCOPE

A microscope is an optical instrument that magnifies extremely small objects so they can be seen easily. Anton van Leeuwenhoek popularized the microscope in the numerous papers he wrote on his observations. By the 1800s, better glass-making methods produced lenses with less distortion and, thus, better quality microscopes.

MOHS' SCALE OF HARDNESS

Used to make relative determinations of hardness of different substances, the Mohs' Scale of Hardness uses ten minerals as indicators—from talc, the softest, to diamond, the hardest. Hardness refers to the resistance of the substance to surface abrasion so that of two solids, the one that will scratch the other is the harder. The scale was invented by the German mineralogist Friedrich Mohs in 1822.

MONOCLONAL ANTIBODIES

First produced by a clone of cells in the laboratories of Sanger and Barrett and Maxam and Gilbert in 1975, monoclonal antibodies have become increasingly important in immunological research. By the isolation of cells which produce the same antibody and their reproduction, pure antibody can be isolated for research into cures for specific diseases such as different forms of cancer.

MUTATIONS

Mutations, which result in new hereditary characteristics in offspring, were first deemed significant by Hugo de Vries in 1900. However, because of the difficulty of studying them, it was not until 1927 (when Herman Muller demonstrated that X-rays could cause mutations much

like natural ones) that research advances were made in their occurrence.

NATURAL SELECTION

Also called survival of the fittest, natural selection was explained during the 1850s by the British naturalist Charles Darwin. He believed that all plants and animals developed gradually from a few common ancestors and that organisms that were best adapted to their environment survived while the less well adapted ones died out.

NUCLEAR FISSION

Nuclear fission is a type of nuclear reaction in which the compound nucleus splits into two nearly equal parts, releasing large amounts of energy. In the 1930s, Enrico Fermi and his co-workers showed that there was a chain reaction when neutrons bombarded uranium. This discovery set the stage for both the atomic bomb and atomic energy.

OXYGEN

Oxygen, the most abundant element on the surface of the earth, was first found in its gaseous elemental form (O_2) and announced publicly by the English clergyman Joseph Priestley. This discovery, plus Lavoisier's work on combustion, led to the establishment of the law of conservation of matter.

PAPER CHROMATOGRAPHY

Paper chromatography, a method of separating substances that make up a mixture, was used by Erwin Chargaff to separate the organic bases of deoxyribonucleic acid (DNA). This careful process, employing absorbent paper and solvent, generated data necessary for establishment of the base pairing rule which led to the determination of DNA's structure.

PENDULUM

Galileo discovered that the time it takes a pendulum to swing back and forth through small distances depends neither on its mass nor on the length of the arc through which it swings. The time of swing depends only on the length of the pendulum and the acceleration of a free-falling body. The Dutch physicist Huygens revolutionized timekeeping by applying Galileo's theories in the construction of a grandfather's clock.

PERIODIC TABLE

Discovered almost simultaneously by the German Lothar Meyer and the Russian Dmitry Ivanovich Mendeleev, the periodic table is a classification of the chemical elements by their atomic numbers. It allows the systematic explanation and prediction of most of the elements' chemical and physical properties and, in fact, was instrumental in its own completion by making obvious where elements were still to be discovered.

PHOTOELECTRIC EFFECT

Photoelectric effect, or the ability of a bright beam of light causing metals to release electrons which could become an electric current, was explained by Albert Einstein in 1905. He showed that when quanta of light energy strike metallic atoms, the quanta force the atoms to release electrons; this was verified experimentally by the American physicist Robert Millikan.

PHOTOSYNTHESIS

Photosynthesis is the process by which chlorophyll-containing green plants, when exposed to light under suitable conditions of temperature and water supply, use carbon dioxide from the atmosphere, release oxygen to it, and synthesize carbohydrates. In chloroplasts, light causes carbon dioxide to combine with hydrogen atoms of water to form sugar with oxygen given off as a by-product; from sugar, together with nitrogen, sulphur, and phosphorous, green plants manufacture carbohydrates, lipids, proteins, and other cell products.

PLANETARY POSITIONS/MOTION

In the mid-sixteenth century, the astronomer Copernicus determined planetary positions, giving support to the idea of a sun-centered universe. His work was further elucidated by the determination of the planets' elliptical orbits by Johann Kepler in the latter part of the sixteenth century.

PLASTICS (SYNTHETIC POLYMERS)

Plastics are synthetic materials that can be shaped into almost any form and can have the hardness of metal or the softness of silk. In 1909, the chemist Leo Hendrik Baekeland invented the first completely synthetic resin, called Bakelite. Since that time, numerous other polymers have been produced, including nylon, polyvinyl, and polypropylene.

PLATE TECTONICS

Plate tectonics, a revolutionary concept in earth science, proposes that the outermost shell of the earth, or lithosphere, is divided into a number of rigid floating plates, the movement of which results in mountain chains, oceanic rifts, and faults. Although similar ideas were expressed as early as 1920, it was not until 1956 that Stanley Keith Runcorn unified the earth sciences by presenting this theory, accompanied by substantial evidence.

PRINCIPLE OF THE LEVER

Discovered by Archimedes in the third century B.C., the principle of the lever—the simplest machine—explains that by application of a small force through a large distance, a large force can be exerted through a small distance. Although the forces can be different, the amount of energy applied is equal to the amount of energy exerted.

QUANTUM THEORY

The quantum theory, developed by Max Planck in 1900, states that energy is radiated in indivisible units called quanta, or photons. Radiant

energy is composed of quanta. It further states that all material particles have wave properties.

RADIOACTIVE DATING

Radioactive dating, the method for finding the age of rocks, is based on the radioactive decay of certain radioactive elements. This process is the inverse of half-life measurement and assumes that the concentration of the radioactive element is changed only by natural decay processes. Through this technique, much of geologic time has been established.

RADIOACTIVITY

Radioactivity is the process by which atoms emit radiation or atomic particles and rays of high energy from the disintegration of their nuclei. It was discovered by the Frenchman Becquerel in 1896 and was further explained through the work of Pierre and Marie Curie. In medical research, this phenomenon has been found to result in both sickness (overexposure leading to leukemia) and health (radiation therapy for cancer victims).

REFLEX CONDITIONING

Reflex conditioning involves the pairing of stimuli to produce a reflex substitution. It was researched by the Russian physiologist Ivan Pavlov. In his observations of dog salivation when smelling food, Pavlov found that the flow of saliva was a conditioned response rather than an autonomic reaction to the smell of food.

RELATIVITY

Relativity is a theory which unifies the concepts of matter and energy (E) with the famous equation $E = mc^2$, in which m = mass and c = the velocity of light. Einstein's first paper on this subject in 1905 changed physics from the view of Newton by pointing out that nothing in the universe is at rest, for even this piece of paper is hurtling through the universe on the spinning planet earth.

RESONANCE

The concept of resonance, formulated by Linus Pauling, suggests a distribution of electronic charge among bonded atoms. Consequently, the molecule actually exists in two forms, each reacting in a different way and both being of the same energy because of the symmetry of their geometrical configurations.

ROCKETRY

It is generally believed that the Chinese invented rockets; but as a modern science, rocketry was largely developed by the American scientist Robert Goddard. In 1926, Goddard conducted the first successful launch of a liquid-propellant rocket, paving the way for further development of space flight.

SPECTROSCOPY

The science of spectroscopy was founded by Gustav Kirchoff, who found that a chemical analysis of substances could be made by examination of their spectral lines. Parts of the absorption spectrum are unique for each compound, just as a fingerprint is unique for a human.

STEREOCHEMISTRY

The branch of chemistry that is concerned with the three-dimensional structure, bond angles, and bond lengths of molecules is called stereochemistry. The existence and importance of this relative orientation of atoms was elucidated by Emil Fischer around the turn of the century.

SUN POWER/SOLAR ENERGY

Solar power is the energy in sunlight providing light and heat for the earth and was first used as an energy source by the Greeks and Romans. With the development of technology, scientists have built solar heating devices and electrical storage cells called photovoltaic cells; but the possibilities for harnessing the energy from the sun are still largely unconquered.

SUPERNOVAS

Supernovas are stars which explode, produce light many times brighter than the sun, and actually eject most of their mass. Tycho Brahe's sighting of a supernova in 1572 helped disprove the idea that no change could occur in the heavens beyond the orbit of the moon.

THE "PILL"

The "pill" is the common name for a large number of hormonal compounds used to prevent pregnancy by suppressing ovulation. Although various kinds of contraception have been used for centuries, oral contraceptives, developed in 1960 and now taken by over 50 million women worldwide, contributed to a dramatic change in the role of women in some societies and a new era of health research.

TRANSISTORS AND SILICON CHIPS

A transistor is an electrical valve that can control the flow of electricity. It usually has three metal contacts, and the current flowing between two of the contacts is controlled by the voltage applied to the third. The transistor, invented by a group of researchers at Bell Laboratories (Brattain, Shockley, and Bardeen) in 1947, not only replaced the vacuum tube in radio and television but also made possible tremendous advances in such fields as computers and communications, partly because it can be made so small that thousands can be built on a tiny "chip" of silicon.

UNCERTAINTY PRINCIPLE

Developed by Werner Heisenberg, the uncertainty principle states that the position and the velocity of an electron in motion cannot simultaneously be measured with accuracy. Heisenberg's research provided the foundation for the more precise theory of atoms called the quantum theory.

VACCINATION

Vaccination, or active immunization, is the process of protecting the body against disease by means of inoculating an individual with a modified form of the disease-causing material. This process was discovered by Edward Jenner in 1796 and has led to vaccinations against such diseases as poliomyelitis, typhus, and yellow fever.

VITAMINS

In 1912, a Polish biochemist, Casimir Funk, coined the term "vitamine," meaning amine essential to life, since their deficiency resulted in nutritional diseases. Vitamins are carbon-containing substances (not necessarily amines) that the body requires for normal metabolism but in general are not synthesized in the body and thus must be obtained from outside sources. Working as co-factors in the body, vitamins are required to carry out enzymatic processes in an expedient manner.

X-RAYS

X-rays refer to the electromagnetic radiation (like visible light) but with extremely short wavelengths (less than 100 angstroms) which are produced by bombarding a target with electrons in a vacuum. In 1895, Wilhelm Roentgen of Wurzburg, Germany, discovered X-rays accidentally while experimenting with a vacuum tube and observing the fluorescence emanating from a spot where the cathode ray struck the tube. X-rays have been used extensively in medical applications and also in such far-reaching fields as anthropology.

YOUNG'S MODULUS

Developed from investigations by Thomas Young, Young's modulus is a measure of how well a solid resists deforming forces—or a ratio of stress to strain. A solid with a large modulus value would have a strong resistance to stress.

APPENDIX III: SCIENTIFIC LITERATURE (That Elementary Students Should Read)*

Adams, A. (1982). *Poetry of Earth*. NY: Charles Scribner's Sons.

This is a collection of nature poems which were chosen and illustrated by the author and are suitable for all elementary students. The selections, including works by Sandburg, Frost, Dickinson, and others, allow the reader to sense our relationship with the earth.

Adamson, J. (1961). *Living Free: The Story of Elsa and Her Cubs*. NY: Harcourt, Brace and World.

For upper elementary students, this story explores the very special relationships between human and animal. It follows *Born Free*, which described how a lion cub was brought up with humans.

Adkins, J. (1975). *Inside: Seeing Beneath the Surface*. NY: Walker.

This book, a visual experience in cross-section showing objects from apples to airliners as they would look if cut in half, is suitable for ages eight to twelve. It allows the development of perception—in how natural objects, such as a tree or valley, or human-made objects, such as a pen or house, are constructed.

Anderson, N. D., and W. R. Brown. (1981). *Halley's Comet*. NY: Dodd, Mead.

The authors give a historical accounting of the comet as well as an explanation of its properties. For upper elementary grades, the book also discusses how to view the comet, which was particularly significant to its 1985-86 appearance.

Arnosky, J. (1982). *Freshwater Fish and Fishing*. NY: Four Winds Press.

The reader is free to enjoy the wonders of the freshwater world by looking at habitats of different kinds of freshwater fish. For grades four to six, it also includes instructions on how to catch fish, tie flies, and make fish prints.

Asimov, I. (1969). *Great Ideas of Science*. Boston: Houghton Mifflin.

Asimov relates the development of scientific ideas through historical accountings of great scientists. From the Greek Thales's concept of science to Darwin's ideas on evolution, he shows how scientific theories were used to develop new ones. (Ages ten to adult)

Asimov, I. (1981). *How Did We Find Out About Solar Power?* NY: Walker.

For the upper elementary student, Asimov's book presents a very readable history of and possible future for our greatest power source, the sun. This is one of a series written by Asimov (*How Did We Find Out?*), all of which give a historical basis for the process of discovery in scientific fields.

Attenborough, D. (1979). *Life on Earth: A Natural History*. Boston: Little, Brown.

Adapted into a television series, Attenborough's work presents a comprehensive history of nature, from single-celled animals to primitive man. He traces the most significant thread in the history of each major group of living things. (Ages ten to adult)

*Some of these recommended readings are currently out of print. It is hoped that their appearance here will create a demand for reissuance.

Atwood, A. (1971). *Haiku: The Mood of the Earth*. NY: Charles Scribner's Sons

This book of Haiku poems, all of which have themes of nature, is classically illustrated by photograph and word. It explores the beauty and design of the natural world. Included are pictures of birds, sea shells, and waves which are described in the poetry. (All ages)

Ault, R. (1983). *Basic Programming for Kids*. Boston: Houghton Mifflin.

Ault's book allows students to have fun with computers while learning fundamentals of programming concepts. As computers become integrated into their classroom experiences, this book will be especially useful for students in grades four to six.

Barton, J. G. (1963). *Wildflowers*. London: Spring Books.

Following an introductory explanation of flower parts and their development, the book is constructed like a field guide with pictures and descriptions. For ages ten to adult, this British publication helps in recognition of wild herbaceous flowering plants.

Baylor, B. (1975). *The Desert Is Theirs*. NY: Charles Scribner's Sons.

This book depicts life in the desert and is appropriate for grades two to six. It stresses the interrelatedness of plants, animals, and Native Americans in this often harsh environment.

Becker, R. W. (1969). *Through My Window*. Minneapolis: T. S. Denison.

Through My Window is a collection of poetry for the curious child, grades one to three, and what he or she might see as he or she looks out his or her window. Most poems are about insects and small animals.

Bendick, J. (1951). *All Around You: A First Look at the World*. NY: Whittlesey House.

This book provides a basic look at natural science for the young reader, grades one to three. It answers questions about the world we live in, such as why we need the sun and how plants take care of themselves.

Berger, M. (1980). *The New Earth Book: Our Changing Planet*. NY: Thomas Y. Crowell.

Written as an introduction to earth science, this book explains how the earth has changed and is changing and how pollution affects it. Simple earth science experiments are provided for the young reader in grades two to six.

Bixby, W. (1964). *The Universe of Galileo and Newton*. NY: American Heritage.

Bixby presents a historical account of Galileo's and Newton's attempts to understand the universe. With great illustrations, the book covers astronomical and scientific instrumentation employed by these two scientists and others of their time, including Robert Hooke and Edmund Halley. (Grades four to six)

Black, H. (1981). *Animal Cooperation: A Look at Sociobiology*. NY: William Morrow.

Based on Darwin's theories on natural selection, this book discusses the controversial idea that behavior patterns have some value for survival. Black discusses inherited animal behaviors as well as the idea that human behavior may also be inherited. (Grades four to six)

Blough, G. O. (1958). *Young People's Book of Science*. NY: Whittlesey House.

In this book, scientific things we use such as lenses for seeing and radios for communication are explained to provide an understanding of the world. Included are scientific explanations of living things, atoms, the sea, and space. (Grades three to six)

Blow, M. (1960). *Men of Science and Invention*. NY: American Heritage.

For grades four to six, this book is a comprehensive historical reference. It traces scientific achievements in America from colonial days through the development of spacecraft.

Boeke, K. (1957). *Cosmic View: The Universe in 40 Jumps*. NY: John Day.

Suitable for ages nine to twelve, this book uses a metric scale to observe almost limitless views of living worlds. It provides an unusual experience in perception by changing orders of magnitude.

Borland, H. (1977). *The Golden Circle: A Book of Months*. NY: Thomas Y. Crowell.

With unique illustrations, *The Golden Circle* provides descriptions of the natural world as it looks and as it changes through the seasons. Primarily a picture book, it includes an essay describing how the natural world looks from month to month and is suitable for kindergarten to third grade.

Burton, V. L. (1962). *Life Story*. NY: Houghton Mifflin.

In full-color paintings, this book traces changes on the earth from its beginnings. The book is written as a five-act play. With simple text and sketches, the reader is drawn to the action on the stage. (Ages nine to twelve,

Carle, E. (1981). *The Very Hungry Caterpillar*. NY: Philomel Books.

This book gives an excellent pictorial explanation of the three processes of metamorphosis. The bold illustrations make it a delight for children, kindergarten to third grade.

Carson, R. (1956). *The Sense of Wonder*. NY: Harper and Row.

Carson allows us to discover the mysteries of the earth, sea, and sky through exceptional photographs and text. Suitable for ages ten to adult, the book follows the journey of discovery with sight, smell, sound, and feeling.

Colbert, E. H. (1983). *Dinosaurs: An Illustrated History*. Maplewood, N.J.: Hammond.

This book takes a historical approach to dinosaurs' beginnings, their habitat, and diversity. The superior illustrations are a complement to the comprehensive text (grades four to six).

Considine, D. M., ed. (1980). *Van Nostrand's Scientific Encyclopedia*. NY: Van Nostrand Reinhold.

This two-volume set provides an exceptional standard reference for all areas of science. For ages ten to adult, it is the book of choice for library and home reference.

Daly, K. N. (1980). *Body Words: A Dictionary of the Human Body, How It Works, and Some of the Things That Affect It*. Garden City, N.Y.: Doubleday.

Body Words is a guidebook for the young reader's discovery of self and is suitable for ages nine to twelve. It includes answers to frequently asked questions about the human body and its functions.

Dowden, A. O. (1975). *The Blossom on the Bough: A Book of Trees*. NY: Thomas Y. Crowell.

This book begins with a look at structure, function, and the growth cycle of the tree. Dowden also discusses the significance of the forest in ecological terms and presents different types in the form of a field guide—with pictures and descriptions. (Grades four to six)

Elwood, A., and L. C. Wood (1982). *Windows in Space*. NY: Walker.

This book of astronomy and space flight covers the interesting advances in our knowledge since the space age began. From walking on the moon to the possibility of living in space, the reader discovers that space exploration is fast becoming a reality. (Grades four to six)

Facklam, M. (1976). *Frozen Snakes and Dinosaur Bones: Exploring a Natural History Museum*. NY: Harcourt Brace Jovanovich.

Facklam gives his readers an opportunity to see what a museum looks like behind the scenes. He also explains how objects are prepared and displayed. (Grades four to six)

Flanagan, G. L. (1975). *Window into a Nest*. Boston: Houghton Mifflin.

For ages nine to twelve, this is an intriguing photographic view of the process of mating and development in a bird family. It is accompanied by personalized and detailed text.

Ford, A. (1981). *Weather Watch*. NY: Lothrop, Lee, and Shepard.

Providing a comprehensive look at the weather with bold illustrations, this book discusses the atmosphere, temperature variation, different kinds of clouds, rain, and dew. It also looks at the processes of forecasting and predicting changes in the weather. (Grades four to six)

Gallob, E. (1972). *City Leaves, City Trees*. NY: Charles Scribner's Sons.

By using a simple key, the reader can identify common trees found in the city as opposed to the forest or other environment. Pictures of their leaves, fruit, and buds, along with descriptions, make this book useful in identification of trees typically found in cities. (Ages eight to twelve)

Gardner, R. (1980). *This Is the Way It Works: A Collection of Machines*. Garden City, NY: Doubleday.

For the curious—with descriptions and illustrations—the author explains how many commonly used machines and tools work. Each explanation is coupled to historical information on how the machines were developed. (Grades four to six)

Gortlieb, W. P. (1983). *Science Facts You Won't Believe*. NY: Franklin Watts.

In an easy to understand style, many misconceptions about science are explained, such as that bats are not blind and shooting stars are not stars. For readers of all ages, this book is fascinating and informative.

Greenberg, P. (1983). *Birds of the World*. NY: Platt and Munk.

This book discusses habits and habitats of birds. It further shows how many have become threatened because of the destruction of their habitats, pollution, or disease. (Grades four to six)

Grosvenor, M. B., ed. (1971). *As We Live and Breathe: The Challenge of Our Environment*. Washington, D.C.: National Geographic Society.

Suitable for ages ten to adult, this book takes an expansive look at air and water pollution, overpopulation, and extravagant uses of energy, as well as possible solutions. The book focuses on how Americans are accepting their ecological responsibilities for environmental problems.

Grosvenor, M. B., ed. (1976). *Our Continent: A Natural History of North America*. Washington, D.C.: National Geographic Society.

Complete with poetry and comprehensive text, this book presents an outstanding visual experience in exploring the natural wonders of our continent, such as the Cascade volcanoes, the Rocky Mountains, and the Grand Canyon of the

Colorado River. For readers aged ten to adult, it provides an exceptional reference for any library collection.

Haines, G. K. (1982). *Test-tube Mysteries*. NY: Dodd, Mead.

This is a fascinating collection of fourteen personal accounts of scientific detection, including the finding of remedies for diseases and discovery of organisms which cause them. The stories show how scientists work and the process of discovery. (Grades four to six)

Heller, R. (1982). *Chickens Aren't the Only Ones*. NY: Grosset and Dunlap.

This is an excellent picture book presenting different kinds of animals which reproduce by laying eggs, such as fish, snails, and turtles. Boldly illustrated, it is a delight for the kindergarten to grade three reader.

Herbst, J. (1983). *Sky Above and Worlds Beyond*. NY: Atheneum.

Herbst's comprehensive view of astronomy includes historic aspects as well as how to explore the heavens for oneself. It explores plans for future space travel and the search for extra-terrestrial life. (Grades four to six)

Hoban, T. (1971). *Look Again*. NY: Macmillan.

Hoban takes photographs of natural objects, zeroes in on a limited view, and then the whole object and its surroundings. Using no words, the book is totally dependent on visual development of young curious minds, grades kindergarten to three.

Horsfall, R. B., and C. E. Horsfall (1978). *Bluebirds Seven*. Portland: Audubon Society.

This story relates the growth and development of a bluebird family. Illustrated with watercolors by the author, it is suitable for kindergarten to

grade three.

Hutchins, R. E. (1965). *The Amazing Seeds*. NY: Dodd, Mead.

This book contains strange and interesting facts about seeds. Photographs are used to illustrate their unique differences. It explains how seeds perpetuate plant life, are a food source, and have unique properties. (Grades three to six)

Kadesch, R. R. (1970). *Math Menagerie*. NY: Harper and Row.

Math Menagerie examines how mathematics work through simple experimentation. Students from grades four to six can decipher mathematical hieroglyphics, maps, and graphs—all necessary skills for the scientist.

Kendall, J. (1953). *Great Discoveries by Young Chemists*. NY: Thomas Y. Crowell.

The author shows examples from throughout history that support the contention that the creative period of many chemists' lives has been the period of early youth. Besides the discoveries made by these young scientists, he describes the formation of the first chemical society and journal. (Grades four to six)

Kipling, R. (1948). *The Jungle Books*. Garden City, NY: Doubleday.

This series of animal stories for readers, ages eight to adult, is in two volumes. The central character is the small boy Mowgli, brought up by Mother Wolf and instructed in jungle lore.

Kohl, J., and H. Kohl. (1977). *A View from the Oak*. San Francisco: Charles Scribner's Sons.

Inspired by Jacob von Uexkull's *A Stroll Through the World of Animals and Men*, this charming book allows the reader to sense the unusual habits and behaviors of living things in the environment. Human behaviors could be

positively influenced by its philosophical nature. (Ages nine to adult)

Lambert, D. (1981). *The Active Earth*. NY: Lothrop, Lee, and Shepard.

This book discusses the forces, such as continental drift, vulcanism, and wind and stream action, which shape the earth. Provided for the reader are investigative projects to see how landforms are made. (Grades three to six)

Lambert, M. (1980). *All Color Book of Science Facts*. NY: Arco.

This book gives a concise, well-illustrated coverage of science, including earth, plants and animals, humans, and technology. For grades three to six, it attempts to explain some of the mysteries of science and the natural world.

Lampton, C. (1983). *DNA and the Creation of New Life*. NY: Arco.

Lampton gives the young reader (grades four to six) a basic understanding of the gene and how genetic engineering has developed. He also addresses the controversial topic of recombinant DNA research.

Leakey, R. E. (1982). *Human Origins*. NY: Lodestar Books.

The son of the famous archaeologist L. S. B. Leakey gives us clues to the past via the fascinating, often controversial field of paleontology. He looks at the special way in which humans have evolved from primates by developing uniquely different behaviors. (Grades four to six)

Leopold, A. (1966). *A Sand County Almanac*. NY: Oxford University Press.

Through his essays, Leopold relates the value of natural ecosystems. For ages ten to adult, it is a powerful book about the land ethic.

London, J. (1964). *The Call of the Wild and White Fang*. NY: Washington Square Press.

London's famous tales of the Yukon are classics. One involves a dog set free to become leader of a wolf pack; the other tells of a wolf tamed into the likeness of a dog. (Ages nine to adult)

Mabey, R. (1983). *Oak and Company*. NY: Greenwillow Books.

Dynamically illustrated, this book traces the growth of an oak tree from a single acorn. As it ages, interrelationships develop between it and other plants and animals: birds eat insects from its leaves, mice live in its hollows, squirrels eat its acorns. (Grades three to six)

McClung, R. M. (1980). *The Amazing Egg*. NY: E. P. Dutton.

From chickens to humans, this book explains the process of reproduction. For grades four to six, it shows the development of baby animals and the diversity of life cycles.

McCoy, J. J. (1978). *In Defense of Animals*. NY: Seabury Press.

This unusual book is a contemporary approach to problems in the humane treatment of animals. It shows how animals have been abused and traces the rise of the animal protection movement.

Milne, L., and M. Milne. (1980). *Gadabouts and Stick-at-Homes*. San Francisco: Sierra Club Books.

In ten chapters, this book discusses ten different wild animals and their habitats. It illustrates the diversity of animal behavior. (Grades three to six)

Mowat, F. (1963). *Never Cry Wolf*. Boston: Little, Brown.

This powerful true story of the wolf and its habitat clarifies some of our misconceptions

about this animal. With increased knowledge and understanding of the wolf, perhaps we can avoid its extinction. (Ages ten to adult)

Sattler, H. R. (1983). *The Illustrated Dinosaur Dictionary*. NY: Lothrop, Lee, and Shepard.

This handy reference is an alphabetical listing of dinosaurs, related animals like the saber-toothed tiger, and terms used in the study of these creatures. The author also includes recent discoveries about them. (Grades three to six)

Schneider, H., and N. Schneider. (1952). *Follow the Sunset*. Garden City, NY: Doubleday.

Simple and beautifully illustrated, *Follow the Sunset* explains day and night around the world. Largely a picture book, it is most suitable for kindergarten to grade three.

Selsam, M. E. (1966). *Benny's Animals and How He Put Them in Order*. NY: Harper and Row.

In a charming story, Selsam cleverly reveals how living things are classified. For a beginning science student, grades one to three, it integrates the story of a curious young boy and the scientific process of classification of living things.

Schapiro, I. (1977). *Darwin and the Enchanted Isles*. NY: Coward, McCann and Geoghegan.

From Darwin's diaries and writings comes this story of his voyage on the Beagle and his findings. It traces the route of the Beagle and discusses Darwin's decision to become a scientist. (Grades four to six)

Silverstein, A., and V. Silverstein. (1979). *The World of Bionics*. NY: Methuen.

Good ideas from nature, such as the development of airplanes from birds, or seeing machines from animal eye research, are put to use by scientists

for expanding humanity's domain. The book covers the new area of scientific research, studying systems that imitate life. (Grades four to six)

Silverstein, A., and V. Silverstein. (1980). *Nature's Champions: The Biggest, the Fastest, the Best*. NY: Random House.

Nature's Champions provides concise descriptions and statistics on unique plants and animals. Included are tales of the fastest and the slowest animals as well as the smartest—human beings. (Grades three to six)

Simon, S. (1983). *Hidden Worlds: Pictures of the Invisible*. NY: Morrow.

This book traces the development of technology for viewing very small or very faraway objects. The reader can view both worlds via the photographs in this book. Suitable for grades four to six, it discusses the instruments which have been developed for these observations.

Smith, H. E., Jr. (1982). *Living Fossils*. NY: Dodd, Mead.

This book takes a look at plants and animals which have changed little over time, such as the cockroach and horseshoe crab, providing clues to earth's natural history. It examines the luck or design by which these creatures have endured. (Grades three to six)

Taylor, R. (1981). *The Story of Evolution*. NY: Warwick Press.

Powerfully illustrated, this study discusses the theories of Darwin, Wallace, and other scientists. It offers explanations for how living things have changed, what causes variety, and how modern technology may influence change. (Grades four to six)

Trefil, J. S. (1983). *The Unexpected Vista: A Physicist's View of Nature*. NY: Charles Scribner's Sons.

With an inquiry approach, Trefil examines a dozen simple questions, such as why the sky is blue or why there are no rainbows in winter, from a physicist's point of view. He gives the reader awareness of the interrelatedness of natural laws. (Ages ten to adult)

Visner, H., and A. Hectlinger. (1971). *Simple Science Experiments*. Palisades, N.J.: Franklin.

Frequently asked science questions are answered for fourth to sixth graders. Experiments are outlined which explain some scientific principles.

Walters, D. (1982). *Chemistry*. NY: Franklin Watts.

This introductory book covers basic aspects of chemistry (chemical change, acid/base, elements, atomic structure), incorporating simple experiments and illustrations. It is easy to understand for the young scientist, aged eight to twelve.

Weiss, M. E. (1982). *Sky Watchers of Ages Past*. Boston: Houghton Mifflin.

Astronomy is the oldest of the sciences. Weiss's book explains how native peoples of the western world studied the heavens and what they learned. (Grades four to six)

Wells, H. G. (1968). *The Time Machine*. NY: Bantam.

Wells's science fiction classic tells of a time traveler traveling into the future. During his trip, he visits stages in the evolutionary degeneration of life on earth. (Ages ten to adult)

Wells, H. G. (1960). *The War of the Worlds*. NY: Random House.

This science fiction classic is an exciting story of space. It explores the possibility of life in other worlds. (Ages ten to adult)

Wilson, M. (1960). *American Science and Invention*. NY: Bonanza.

This book provides a pictorial, historical accounting of those who have influenced our knowledge of American physical science. For grades four to six, this book provides a handy reference because of its thorough coverage of American scientists and their inventions.

Wilson, R. (1980). *How Plants Grow*. NY: Larousse.

This book gives concise explanations and illustrations of the development and structure of plant life. Wilson discusses plant cells, photosynthesis, respiration and transpiration, and ecological relationships and conservation.

Wolff, A. (1984). *A Year of Birds*. NY: Dodd, Mead.

This charming picture book of birds which can be seen each month shows the continuity of time, shared patterns of life, and a loving family who observe the birds. The pictures are beautiful watercolors. (Kindergarten to grade three)

Yates, M. (1982). *Sun Power: The Story of Solar Energy*. Nashville: Abington.

As the sun explodes, great amounts of energy are released in space. This current book on energy from the sun traces the history and future of solar power.

APPENDIX IV: SCIENCE MATERIALS

MATERIALS LIST K-3

aluminum foil	marking pens
apples	matches
aquarium	meter sticks
	microscope
bags, lunch	mirrors
bags, plastic sandwich bags	
balloons	nails
balls	napkins
bean seeds	needle, steel
	newspapers
cans, coffee	
cans, empty tin cans	paper, butcher, construction, drawing
chalk, white	paint
clay	paper clips
cloth, different materials 20 cm sq.	paper towels
coins	paste
cotton, balls	pencils
crayons	pie pans, metal
cups, measuring	plants, live
cups, plastic	plates, paper
detergent, liquid	record player
	rocks, samples
egg cartons, empty	rubber bands
eye droppers	rulers, wooden
fish from store	salt
fish food	sand
flashlight	sandpaper
flowers, assorted	scale, bathroom
food coloring	scale, kitchen
foods with distinct odors	scissors
	seeds, assorted
globe	shoe boxes
glue	sponge
	spoons
hammer	stopwatch
hand lenses	straws
	string
ice	sugar
index cards	
	tape, masking
jars, large glass	tape, plastic
jars, wide mouth	thermometer (°C)
	thumbtacks
knife	toothpicks
knives, plastic	
	vinegar
lamps	
leaves, different shapes	washers
	waxed paper
magazines	wire, copper insulated
magnets	woodblocks
marbles	yarn

MATERIALS LIST 4-6

aluminum foil	marking pens
apple	measuring cup
aquarium	meterstick
	microscope
baking soda	microscope slides
balances	milk containers
balloons	
balls	nails, iron
battery (dry cell, 1.5 volt)	newspapers
batteries (D cell)	
blocks of wood	paper (construction, drawing, tracing)
buttons	paper towels
	pencils
cans, tin	petroleum jelly
cardboard	plaster of Paris
chalk	plastic wrap
clay	pins
compasses	potatoes
coins	pots
cotton	
cloth, wool	rock samples (granite, limestone, marble, sandstone, slate, volcanic)
cover slips	
cups, paper	
	salt
egg whites	sand
elodea plant	sandwich bags
eyedroppers	scissors
	seeds, beans
flashlight	shells, assorted
food coloring	soap, liquid
funnel	soil, potting
	spoons
glasses, drinking	spoons, measuring
glue	straws
gravel	string
hammer	tape, masking and plastic
hand lenses	test tubes
	toothpicks
ice cubes	tweezers
iodine	thermometers
iron filings	
	vinegar
keys	
knife	wire cutter
	wire stripper
lamp	wire, telephone
light bulbs and sockets	washers
lime juice	
magazines	
magnets, bar	

MATERIALS LIST 7-8

- acetate, clear sheet
acetic acid
alcohol lamps
alcohol, rubbing-isopropyl, ethyl
aluminum foil
ammonia, household
aquarium, glass
- bags, plastic sandwich
balance, triple beam
balls, different sizes
batteries, D size and 6 volt
beakers, graduated, 150 mL
beakers, graduated, 250 mL
beakers, graduated, 500 mL
Benedict's solution
bleach, liquid
blocks, wood 4x4 cm
blood pressure cuff (sphygmomanometer)
borax
bowl, large mixing
Bunsen burner
- cardboard
chalk
chicken leg bones
clay, modeling
clock with second hand
club soda
compasses, drawing
compasses, directional
corn starch
cotton balls
cover slips
cultures, living:
 amoeba
 daphnia
 hydra
 mealworms
 Parameciums
 earthworms
 yeast
- cups, paper
cups, Styrofoam
cylinders, graduated, 50 mL
cylinders, graduated, 100 mL
cylinders, graduated, 250 mL
- dishes, rectangular
dissecting needle
droppers, medicine
- electrolysis kit
elodea
Epsom salts
erasers, rubber
- filter paper
flashlight
flasks, Erlenmeyer, 250 mL
flour
flower samples
food coloring
forceps
funnels, plastic
- gastric juice
glucose
- hand lenses
hot plate
hydrochloric acid, dilute
hydrogen peroxide, 3%
- ice
index cards 3x5
iodine solution
juice, lemon or grapefruit
- lamp base, miniature
lamps, miniature, 1.5 volt
lens, 10-cm focal length
light bulb, 200 watt
limewater
litmus paper
magnet, bar
marble chips
marbles, 1.2-cm glass
markers, felt pens
marshmallows
maps, weather
matches, safety
measuring cups
metersticks
microscopes
microscope slides
microscope slides, depression
mineral samples
mirror, small square or rectangular
- nails, 6d steel
nails, 16d finishing
needle, sewing
newspaper
nylon stocking

MATERIALS LIST 7-8

(page 2)

pan, aluminum pie
paper, graph
pencil, glass marking
petri dishes with covers and agar
plastic bottles, 200 mL
plastic wrap
plaster of Paris
potassium dichromate
potassium permanganate
prisms
protractors
pulley, single

ring stand and ring
rock salt
rock samples
rod, glass and metal
rubber bands
rulers, 30 cm

safety goggles
salt, table
sand, fine
scissors
seltzer tablets
seeds, variety (corn, radish, pea, bean)
sodium bicarbonate
sodium hydroxide
soil, potting
splint, wood
spring scale
stethoscope
stoppers, cork (for test tubes)
straws, drinking
sugar, table
sulfur, small lump

tape, masking
tape, transparent
test tube brush, cleaning
test clamps
test tube rack
test tubes, Pyrex, 30 mL
test tube stoppers, rubber
thermometer -10° C to 100° C
thumbtacks
toothpicks
towels, paper
tripod
tubing glass

vinegar
vitamin C (ascorbic acid)

washers, small
water, distilled
wire, copper insulated
wire, gauze
wire, steel

Publications Available from the Department of Education

This publication is one of over 600 that are available from the California State Department of Education. Some of the more recent publications or those most widely used are the following:

ISBN	Title (Date of publication)	Price
0-8011-0271-5	Academic Honesty (1986).....	\$2 50
0-8011-0471-8	Addendum to the 1985-86 California Private School Directory (1986).....	7 75
0-8011-0272-3	Administration of Maintenance and Operations in California School Districts (1986).....	6.75
0-8011-0216-2	Bilingual-Crosscultural Teacher Aides. A Resource Guide (1984).....	3 50
0-8011-0238-3	Boating the Right Way (1985).....	4 00
0-8011-0275-8	California Dropouts - A Status Report (1986).....	2 50
0-8011-0472-6	California Private School Directory (1986).....	9 00
0-8011-0473-4	California Public School Directory (1987).....	14 00
0-8011-0488-2	Caught in the Middle: Educational Reform for Young Adolescents in California Schools (1987).....	5 00
0-8011-0493-9	Challenge of Excellence: Annual Report, 1986 (1987).....	3 00
0-8011-0241-3	Computer Applications Planning (1985).....	5 00
0-8011-0242-1	Computers in Education. Goals and Content (1985).....	2 50
0-8011-0659-1	Educational Software Preview Guide (1987).....	2 00
0-8011-0243-X	Elementary School Program Quality Criteria (1985).....	3 25
0-8011-0041-0	English-Language Arts Framework for California Public Schools (1987).....	3 00
0-8011-0663-X	English-Language Arts Model Curriculum Guide (1987).....	2 25
0-8011-0247-2	Handbook for Conducting an Elementary Program Review (1985).....	4 50
0-8011-0248-0	Handbook for Conducting a Secondary Program Review (1985).....	4 50
0-8011-0289-8	Handbook for Physical Education (1986).....	4 50
0-8011-0249-9	Handbook for Planning an Effective Foreign Language Program (1985).....	3 50
0-8011-0179-4	Handbook for Planning an Effective Mathematics Program (1982).....	2 00
0-8011-0290-1	Handbook for Planning an Effective Writing Program (1986).....	2.50
0-8011-0224-3	Handbook for Teaching Cantonese-Speaking Students (1984).....	4 50
0-8011-0291-X	Handbook for Teaching Filipino-Speaking Students (1986).....	4.50
0-8011-0204-9	Handbook for Teaching Portuguese-Speaking Students (1983).....	4 50
0-8011-0250-2	Handbook on California Education for Language Minority Parents - Chinese. English Edition (1985).....	3 25*
0-8011-0227-8	Individual Learning Programs for Limited-English-Proficient Students (1984).....	3 50
0-8011-0466-1	Instructional Patterns: Curriculum for Parenthood Education (1985).....	12 00
0-8011-0208-1	Manual of First-Aid Practices for School Bus Drivers (1983).....	1.75
0-8011-0209-X	Martin Luther King, Jr., 1929 - 1968 (1983).....	3 25
0-8011-0358-4	Mathematics Framework for California Public Schools (1985).....	3 00
0-8011-0664-8	Mathematics Model Curriculum Guide (1987).....	2.75
0-8011-0252-9	Model Curriculum Standards: Grades Nine Through Twelve (1985).....	5 50
0-8011-0229-4	Nutrition Education—Choose Well, Be Well. A Curriculum Guide for Junior High School (1984).....	8.00
0-8011-0228-6	Nutrition Education—Choose Well, Be Well. A Curriculum Guide for High School (1984).....	8.00
0-8011-0182-4	Nutrition Education—Choose Well, Be Well. A Curriculum Guide for Preschool and Kindergarten (1982).....	8.00
0-8011-0183-2	Nutrition Education—Choose Well, Be Well. A Curriculum Guide for the Primary Grades (1982).....	8 00
0-8011-0184-0	Nutrition Education—Choose Well, Be Well. A Curriculum Guide for the Upper Elementary Grades (1982).....	8 00
0-8011-0230-8	Nutrition Education—Choose Well, Be Well. A Resource Manual for Parent and Community Involvement in Nutrition Education Programs (1984).....	4 50
0-8011-0185-9	Nutrition Education—Choose Well, Be Well. A Resource Manual for Preschool, Kindergarten, and Elementary Teachers (1982).....	2.25
0-8011-0186-7	Nutrition Education—Choose Well, Be Well. A Resource Manual for Secondary Teachers (1982).....	2 25
0-8011-0253-7	Nutrition Education—Choose Well, Be Well: Food Photo Cards (with nutrient composition charts) (1985).....	10 00
0-8011-0254-5	Nutrition Education—Choose Well, Be Well: Teaching Materials for Preschool/Kindergarten Curriculum Guide (in color) (1985).....	7 50
0-8011-0255-3	Nutrition Education—Compute Well, Be Well: Computer Activities for the Classroom, Preschool/Kindergarten (1985).....	12.50
0-8011-0256-1	Nutrition Education—Compute Well, Be Well: Computer Activities for the Classroom, Grades 1-3 (1985).....	12 50
0-8011-0257-X	Nutrition Education—Compute Well, Be Well: Computer Activities for the Classroom, Grades 4-6 (1985).....	12.50

*The following editions are also available, at the same price. Armenian/English, Cambodian/English, Hmong/English, Korean/English, Laotian/English, Spanish/English, and Vietnamese/English

0-8011-0303-7	A Parent's Handbook on California Education (1986)	3.25
0-8011-0305-3	Paths Through High School A California Curriculum Study (1987)	4.00
0-8011-0671-0	Practical Ideas for Teaching Writing as a Process (1987)	6.00
0-8011-0309-6	Program Guidelines for Hearing Impaired Individuals (1986)	6.00
0-8011-0258-8	Program Guidelines for Severely Orthopedically Impaired Individuals (1985)	6.00
0-8011-0310-X	Program Guidelines for Visually Impaired Individuals (1986)	6.00
0-8011-0213-8	Raising Expectations: Model Graduation Requirements (1983)	2.75
0-8011-0311-8	Recommended Readings in Literature, K-8 (1986)	2.25
0-8011-0214-6	School Attendance Improvement. A Blueprint for Action (1983)	2.75
0-8011-0189-1	Science Education for the 1980s (1982)	2.50
0-8011-0339-8	Science Framework for California Public Schools (1978)	3.00
0-8011-0354-1	Science Framework Addendum (1984)	3.00
0-8011-0665-6	Science Model Curriculum Guide (1987)	3.25
0-8011-0262-6	Secondary School Program Quality Criteria (1985)	3.25
0-8011-0315-0	Selected Financial and Related Data for California Public Schools (1986)	3.00
0-8011-0265-0	Standards for Scoliosis Screening in California Public Schools (1985)	2.50
0-8011-0486-6	Statement on Preparation in Natural Science Expected of Entering Freshmen (1986)	2.50
0-8011-0318-5	Students' Rights and Responsibilities Handbook (1986)	2.75
0-8011-0234-0	Studies on Immersion Education: A Collection for U.S. Educators (1984)	5.00
0-8011-0474-2	Technology in the Curriculum (5 manuals, 5 disks) (1986)	95.00
0-8011-0192-1	Trash Monster Environmental Education Kit (for grade six)	23.00
0-8011-0236-7	University and College Opportunities Handbook (1984)	3.25
0-8011-0344-4	Visual and Performing Arts Framework for California Public Schools (1982)	3.25
0-8011-0237-5	Wet 'n' Safe. Water and Boating Safety, Grades 4-6 (1983)	2.50
0-8011-0194-8	Wizard of Waste Environmental Education Kit (for grade three)	20.00
0-8011-0464-5	Work Permit Handbook (1985)	6.00
0-8011-0648-6	Writing Assessment Handbook (1986)	10.00
0-8011-0270-7	Young and Old Together. A Resource Directory of Intergenerational Resources (1986)	3.00

Orders should be directed to:

California State Department of Education
P.O. Box 271
Sacramento, CA 95802-0271

Please include the International Standard Book Number (ISBN) for each title ordered.

Remittance or purchase order must accompany order. Purchase orders without checks are accepted only from governmental agencies in California. Sales tax should be added to all orders from California purchasers.

A complete list of publications available from the Department, including apprenticeship instructional materials, may be obtained by writing to the address listed above or by calling the sales unit of the Bureau of Publications at (916) 445-1260.